

Quick Installation Manual

Energy Storage System

PowerStack-ST225kWh-110kW-2h-IEC



All Rights Reserved

All Rights Reserved

No part of this document can be reproduced in any form or by any means without the prior written permission of Sungrow Power Supply Co., Ltd (hereinafter "SUNGROW").

Trademarks

SUNGROW and other Sungrow trademarks used in this manual are owned by SUNGROW.

All other trademarks or registered trademarks mentioned in this manual are owned by their respective owners.

Software Licenses

- It is prohibited to use data contained in firmware or software developed by SUNGROW, in part or in full, for commercial purposes by any means.
- It is prohibited to perform reverse engineering, cracking, or any other operations that compromise the original program design of the software developed by SUNGROW.

About This Manual

This manual gives an introduction to the mounting, electrical connection and powering on/off of the Energy Storage System ("ESS").

Target Group

This manual is intended for operators of the energy storage plant and qualified technical persons. The installation and operation must be performed only by qualified technical persons, who must:

- Have received professional training
- Have read through this manual carefully and have a good understanding of the relevant safety instructions
- Be familiar with applicable local standards and the relevant safety code for electrical system

How to Use This Manual

Read the manual and other related documents before performing any operation on the product. Documents must be properly kept and be available at all times.

To increase customer satisfaction, the product and its manual will be updated and improved constantly. If the manual you have received is slightly inconsistent with the real product, it is probably owed to a product update. In such a case, the real product should take precedence. You can find the latest manual at support.sungrowpower.com, or reach your sales for the manual.

The figures in this manual are for reference only. The real product may differ.

Symbols in the Manual

To ensure the safety of life and property for users when using the product and to improve the efficiency of product use, the manual provides relevant safety information, which are highlighted by the following symbols.

Symbols that may appear in this manual are listed below. Please read carefully for better use of this manual.

DANGER

Indicates an imminently hazardous situation which, if not avoided, will result in death or serious injury.

WARNING

Indicates a moderately hazardous situation which, if not avoided, will result in death or serious injury.

CAUTION

Indicates a slightly hazardous situation which, if not avoided, may result in minor or moderate injury.

NOTICE











Indicates a potential hazard which, if not avoided, will result in device malfunction or property damage.





Indicates supplementary information, emphasis on specific points, or tips related to the use of the product that might help to solve your problems or save your time.

Signs on the Product

Observe the safety signs on the product at all times, which include:

Sign	Explanation
	Hot surface! Do not touch. Otherwise, it may cause personal injuries.
	Disconnect the equipment from all the external power sources before maintenance!
	High voltages inside! Touching it may result in an electric shock.
	Danger of death due to high voltages! After the equipment is disconnected from the external power source, wait at least 5 minutes before touching any of its internal conductive parts.
	Beware of heavy weights! Lifting the heavy object directly may cause back injury. Please lift it with the assistance of proper tools.
	Beware of explosion.
	Beware of corrosion.
	Do not dispose of it together with household waste.
	No fires.
	A medical facility should be set up nearby.
	If it gets in your eyes, flush your eyes immediately with running water or saline, and seek medical advice in time.

Sign	Explanation
	Protective earthing (PE) terminal. This terminal should be connected for reliable grounding, to ensure the safety of the operator.
	Read the instructions before performing any operation on the product.
	Wear safety goggles.

Contents

All Rights Reserved	I
About This Manual	II
1 Product Description	1
1.1 Product Overview	1
1.2 External Design	2
1.2.1 ESS External Design	2
1.2.2 Mechanical Parameters	3
1.2.3 Ventilation Design	4
1.3 Internal Design	5
1.3.1 Internal Components	5
1.3.2 PCS (SC125CX)	6
1.3.3 Power Distribution Box	8
1.3.4 Battery	9
1.3.5 EMS Controller (Optional)	11
2 Mechanical Installation	14
2.1 Inspection Before Installation	14
2.1.1 Deliverables Inspection	14
2.1.2 Equipment Inspection	14
2.2 Installation Environment Requirements	14
2.2.1 Installation Site Requirement	14
2.2.2 Foundation Requirements	15
2.2.3 Installation Space Requirements	16
2.3 Handle with Forklift	20
2.4 Hoisting and Transport	21
2.4.1 Precautions	21
2.4.2 Hoisting	22
2.5 ESS Fixing	23
3 Electrical Connection	25
3.1 Precautions	25
3.2 Electrical Connection Overview	25
3.3 Preparation Before Wiring	27

3.3.1 Prepare Installation Tools.....	27
3.3.2 Open Cabinet Door	28
3.3.3 Prepare Cables.....	28
3.3.4 Copper Wire Connection.....	29
3.3.5 Aluminum Wire Connection.....	30
3.3.6 Cable Inlet Design.....	31
3.4 Ground Connection	31
3.5 AC Connection	33
3.5.1 Safety Precautions	33
3.5.2 AC Output Wiring	33
3.6 Communication Wiring.....	34
3.6.1 Ethernet Communication	34
3.6.2 EMS/LC/External FSS Power Supply Wiring	36
3.7 Post-wiring Work	38
4 Battery Connection	40
4.1 Precautions.....	40
4.2 Battery Wiring	41
5 Powering up and Shutdown	45
5.1 Powering up.....	45
5.1.1 Inspection Before Powering up.....	45
5.1.2 Powering on Steps	45
5.2 Shutdown	47
5.2.1 Planned Shutdown.....	47
5.2.2 Emergency Shutdown	47
6 Troubleshooting	48
7 Appendix	49
7.1 Abbreviations	49
7.2 Technical Data	50
7.3 Tightening Torques	51
7.4 Quality Assurance	51
7.5 Contact Information	52

1 Product Description

1.1 Product Overview

The electrical equipment, communication device, temperature control device, and fire suppression system of the ESS all adopt an integrated design. For electrical equipment, the LFP battery system is designed with a liquid cooling system, while the PCS adopts forced air cooling for heat dissipation. The battery system and the PCS are integrated into an all-in-one outdoor-type cabinet. For communication devices, the LC integrates the functions of BSC, and the CMU is built into the PCS. The integrated design makes the entire system more compact in structure and easy to maintain.

With an all-in-one design, the ESS allows flexible configuration and easy installation and O&M, with only a small space required. It also supports ancillary service functions such as demand control, gaining revenue from peak-to-trough price spread, demand response, and virtual plant.

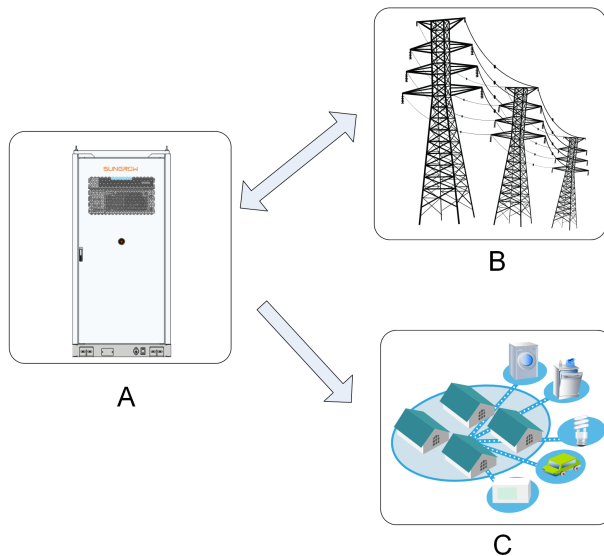

figure 1-1 Typical Application of the ESS

*The figure is for reference only. The real product may differ.

No.	Name
A	ESS
B	Utility grid
C	Loads

1.2 External Design

1.2.1 ESS External Design

The external design of the ESS is shown in the figure below.

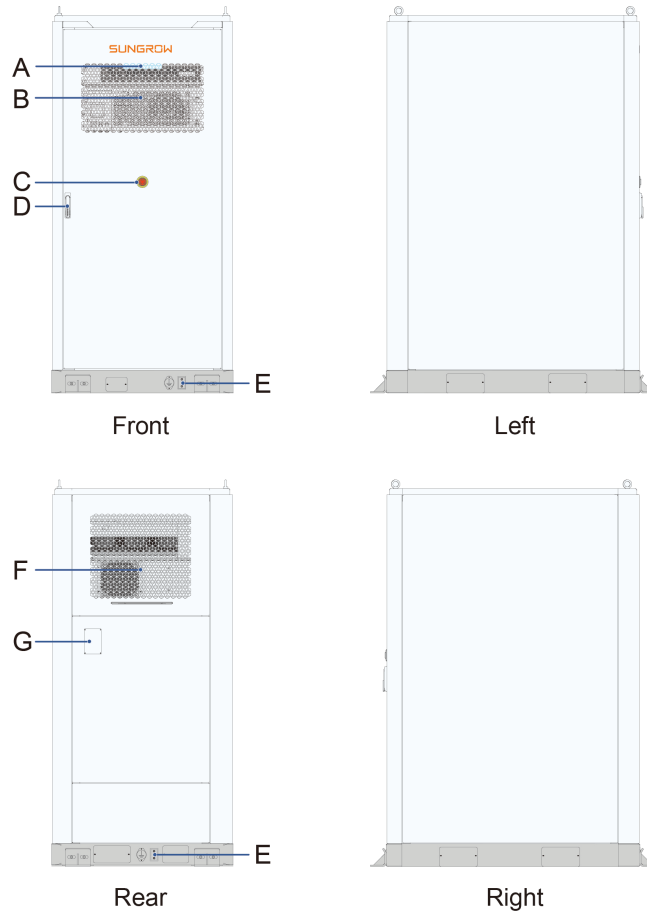

figure 1-2 External Design

*The figure is for reference only. The real product may differ.

No.	Name
A	LED indicator
B	Air inlet
C	Emergency stop button
D	Door lock
E	Grounding point
F	Air outlet
G	Nameplate





NOTICE

The nameplate contains critical parameter information related to the ESS and should be protected against damages during transportation, installation, maintenance, overhaul, and other operations. Do not damage or remove the nameplate!

LED Indicator

The LED indicator is located at the top of the ESS cabinet. The description of the LED indicator status is shown as follows.

table 1-1 LED Indicator Status

Indicator Status	Description
 Steady on	The system works normally (charging/discharging)
 Blink with fading effect at 2s intervals (breathing)	The system is normal and currently not charging/discharging
 Steady on	There is a fault in the system (the auxiliary power supply is not disconnected)
 Off	The auxiliary power supply is disconnected

Emergency Stop Button

In case of an emergency, press this button, and the system will then stop running immediately.

⚠ DANGER

After the emergency stop button is pressed, the system will shut down and the DC contactor will open. However, the internal auxiliary power supply and the PCB board will still carry voltage. Do not touch them!

1.2.2 Mechanical Parameters**Overall Dimensions**

The dimensions of the ESS are shown in the figure below.

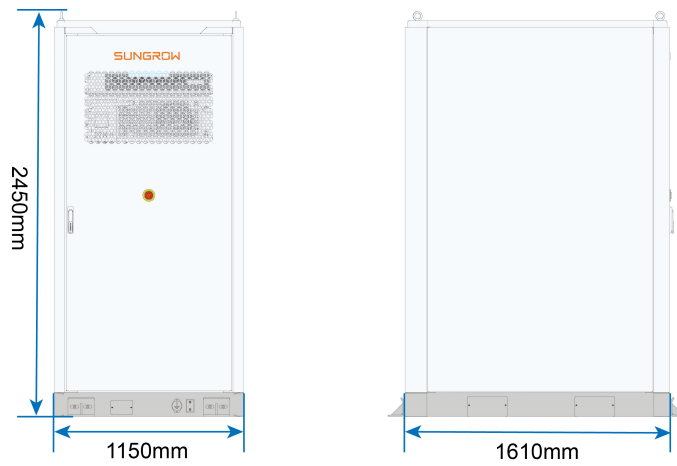

figure 1-3 Overall Dimensions

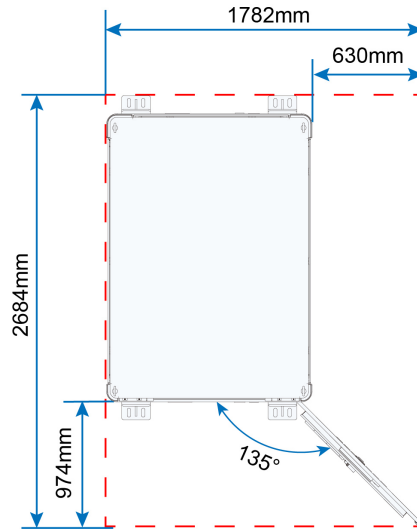

figure 1-4 Dimensions of ESS with Its Door Fully Opened

*The figure is for reference only and the real product may differ.

1.2.3 Ventilation Design

The ESS has an air inlet at its front and an air outlet at its rear, as shown in the figure below.

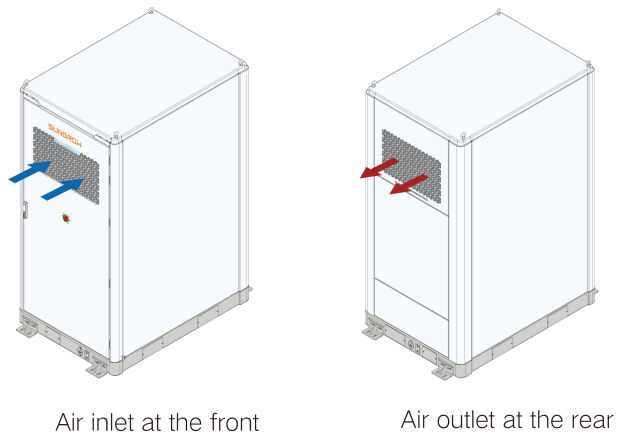

figure 1-5 Air Inlet and Outlet

*The figure is for reference only and the real product may differ.

1.3 Internal Design

1.3.1 Internal Components

The main electrical equipment inside the ESS cabinet are shown below.

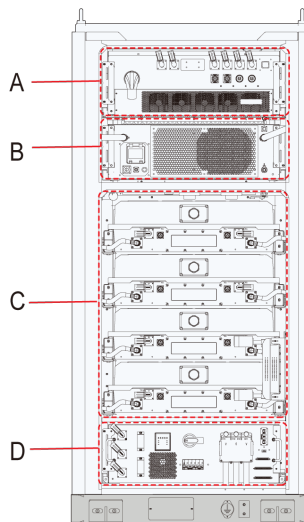

figure 1-6 Internal Structure of ESS Cabinet

No.	Name
A	PCS (SC125CX)
B	Liquid cooling unit
C	Battery RACK (compartment)
D	Power distribution box

*The figure is for reference only and the real product may differ.

1.3.2 PCS (SC125CX)

PCS External Design

The external design of the SC125CX Power Conversion System (PCS) is shown in the figure below.

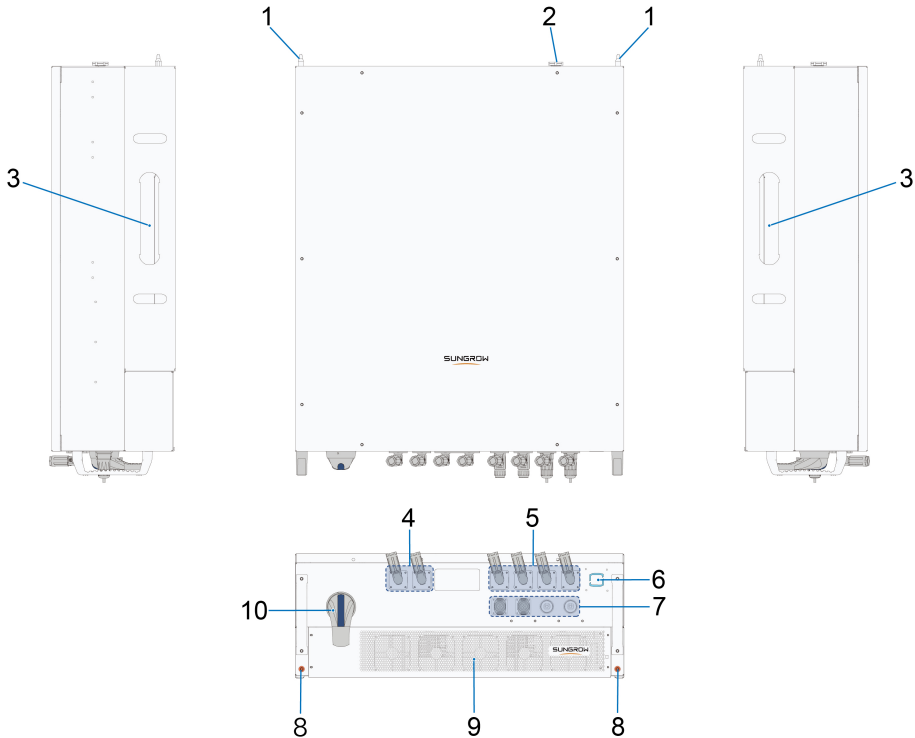

figure 1-7 PCS External Design

*The figure shown here is for reference only. The real product may differ.

No.	Name	Description
1	Locating pin	Used to restrict the free movement of the PCS.
2	Vent valve	Resistant to dust and water; air permeable.
3	Guide rail	Used for the transport, installation, and removal of the device.
4	DC wiring area	-
5	AC wiring area	-
6	LED indicator	Indicates the current operating status.
7	Communication ports	Communication wiring area.
8	*Additional ground-ing terminal	Terminal used for additional protective grounding, as specified in EN 50178.

No.	Name	Description
9	Air inlet cover	Fans are installed at the back of the cover plate, used for forced cooling.
10	DC switch	Used to disconnect the equipment from the battery safely.

WARNING



*** During product use, avoid DC positive/negative-to-ground short circuits and short circuits between positive and negative. Otherwise, it may lead to serious damages to the PCS.**

In case a short circuit fault has occurred, the whole PCS should be replaced.

LED Indicator Panel

The LED indicator panel serves as an interface for human-machine interaction and is used to indicate the current operating status of the PCS.

table 1-2 LED Indicator Status

Indica- tor	Status	Description
	Steady on	The device is running.
	Blink fast (Interval: 0.2s)	The device has connected to bluetooth and data communication is in process.
		There is no fault in the device.
Blue	Blink slow with fading effect (Interval: 2s)	The device has been powered on and is in the emergency stop, standby, or startup state.
	Steady on	A fault has occurred (the device cannot connect to the grid).
	Blink	The device has connected to bluetooth and data communication is in process.
		There is a fault in the device.
Off	Off	The AC and DC sides are both disconnected from power.

1.3.3 Power Distribution Box

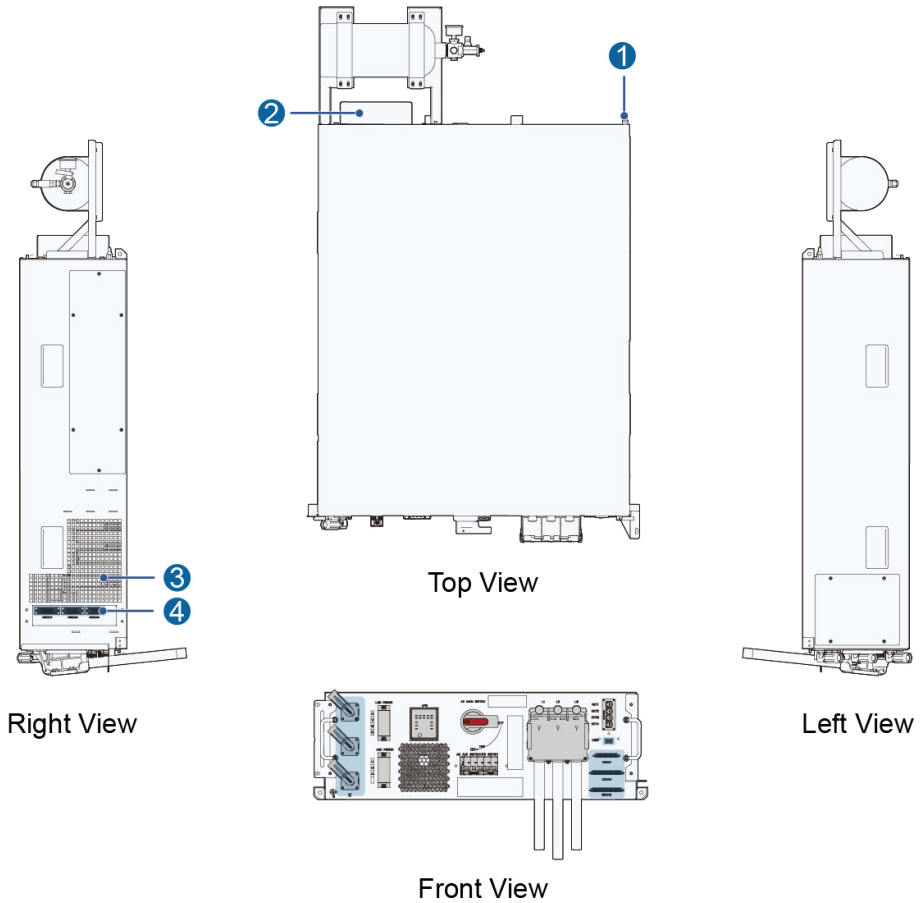

figure 1-8 External Design of Power Distribution Box

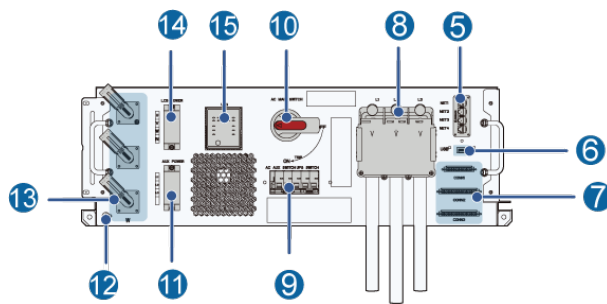

figure 1-9 Operation Panel

*The figure here is for reference only and the real product may differ.

No.	Name	Description
1	Locating pin	Used to restrict the free movement of the power distribution box.
2	Air outlet	Used to exhaust the circulating hot air from the power distribution box.

No.	Name	Description
3	Air inlet	Used to bring circulating cool air into the power distribution box.
4	Connection ports 4–6	Used for power supply or communication wiring of the 24Vdc device inside the cabinet.
5	Communication port	Used for the communication wiring of the equipment.
6	USB port	Port for system operation log transfer.
7	CONN1–3	Ports for FSS, LC, and EMS.
8	AC output port	Used for AC output wiring of the equipment.
9	Miniature circuit breaker (MCB)	Q1 AC auxiliary power supply and UPS control switch.
10	AC MAIN SWITCH	Used to disconnect the equipment from the loads safely.
11	*AUX POWER	Used for external power supply wiring.
12	Additional protective grounding terminal	Terminal used for additional protective grounding, as specified by EN 50178.
13	AC input port	Connected to PCS AC side.
14	LCS POWER	Used for power supply wiring of the liquid cooling unit.
15	UPS	Uninterruptible power supply.

*The system is provided with an internal power supply as standard equipment.

1.3.4 Battery

Cell

table 1-3 Cell Data 1

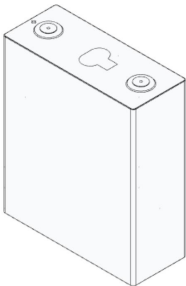
Cell	Parameter	Value
	Dimensions (thickness * height * width)	(71.7±0.8) mm * (207.2±0.8) mm * (173.9±0.8) mm
	Weight	(5.34±0.2) kg
	Rated capacity	280Ah
	Rated energy	896Wh
	Rated voltage	3.2V
	Voltage range	2.5V–3.65V (cell temperature T >0°C)
		2.0V–3.65V (cell temperature T ≤0°C)

PACK

The PACK (battery module) is mainly composed of cells connected in series. It is equipped with functions such as battery voltage and temperature sampling and balancing control. Designed with chips dedicated to battery management, it receives control commands and uploads the collected data over daisy chain communication.

table 1-4 PACK Data 1

PACK	Parameter	Value
	Model	P573-111 / P573B-111
	Dimensions (W*H*D) (wiring terminals and faucets not considered)	(868±5) mm * (247±5) mm * (1442±5) mm
	C Rate	≤0.5C
	Cell type	Prismatic cell with aluminum shell, LFP
	Configuration (series and parallel)	1P64S
	Key components	64 cells, 1 BMU, 1 fuse
	Weight	(395±9.6) kg
	IP rating	IP65

table 1-5 PACK Data 2

PACK	Parameter	Value
	Model	P537AL-111 / P537BL-111
	Dimensions (W*H*D) (wiring terminals and faucets not considered)	(868±5) mm * (247±5) mm * (1442±5) mm
	C Rate	≤0.5C
	Cell type	Prismatic cell with aluminum shell, LFP
	Configuration (series and parallel)	1P60S
	Key components	60 cells, 1 BMU, 1 fuse
	Weight	(378±9.0) kg
	IP rating	IP65

RACK

RACK is mainly composed of several PACKs and fuse.

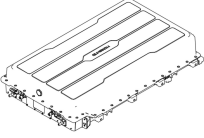
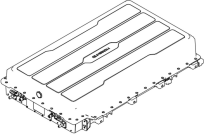
RACK data is shown in the table below.

table 1-6 RACK Data

RACK Model	DC output voltage range	Rated power	Rated voltage	Short-circuit current
R0229BL-ACAA	691.2–934.4V	114kW	819.2V	≤20kA

RACK Structure

table 1-7 RACK Structure

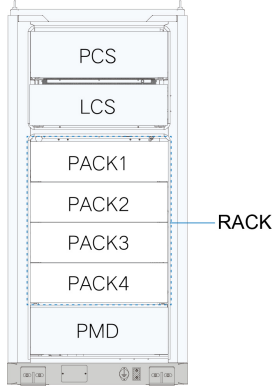
Model	Arrangement
ST225kWh-110kW-2h	

Note:  indicates an 1P64S PACK (battery module). PCS stands for power conversion system, LCS for liquid cooling unit, and PMD for power distribution box.

1.3.5 EMS Controller (Optional)

The EMS300CP energy management system controller can collect the operation data of the ESS and upload it to the iSolarCloud so that users can monitor and control the system operation remotely.

The EMS300CP controller is optional. It is built into the ESS power distribution box. Users can read the label on the power distribution box to understand whether the product has an EMS300CP controller or not.

Auxiliary Meter

In addition to the ESS operation data, the EMS300CP also needs to collect the meter data, as required by some particular functions. Therefore, please install the following two meters first before installing the ESS.

- Gateway meter: Zero export, demand control.
- Electricity meter: Overload protection.

Local Monitoring on Web

The internal communication wiring between the EMS300CP and the ESS has been completed in the factory. Connect the PC to the communication port on the ESS at the site. Then, you can access the EMS300CP Web system on the PC.

The homepage of the EMS300CP Web system is shown below:

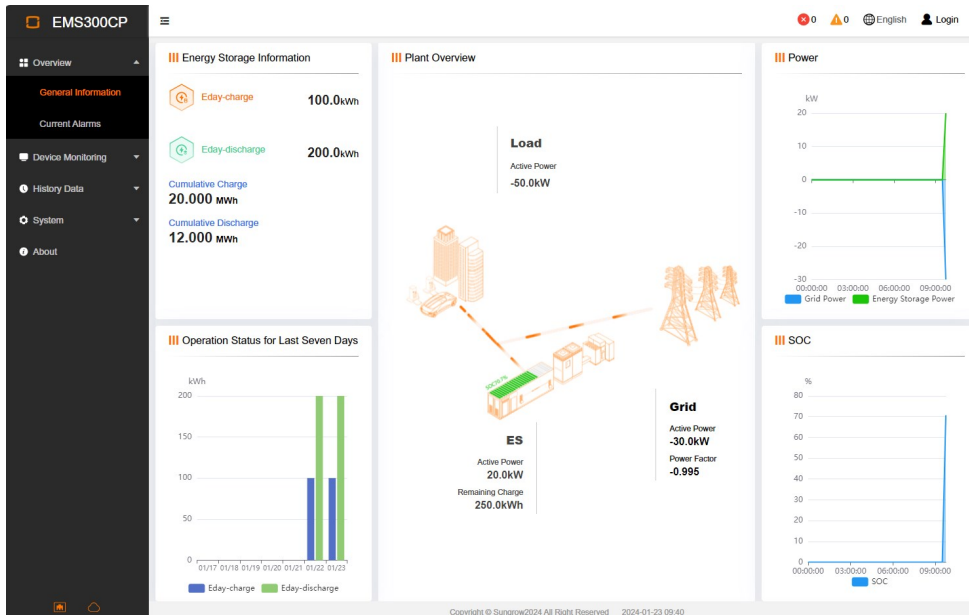

figure 1-10 EMS300CP Web Homepage

You can scan the QR code on the nameplate at the rear of the ESS cabinet to get the



EMS300CP user manual, or scan this QR code directly:

Remote Monitoring on iSolarCloud

You can also monitor the ESS remotely via iSolarCloud. You can log in to the iSolarCloud Web system on the PC, or download the iSolarCloud App from an application store on your



phone: The iSolarCloud App and EMS300CP are connected over WiFi.

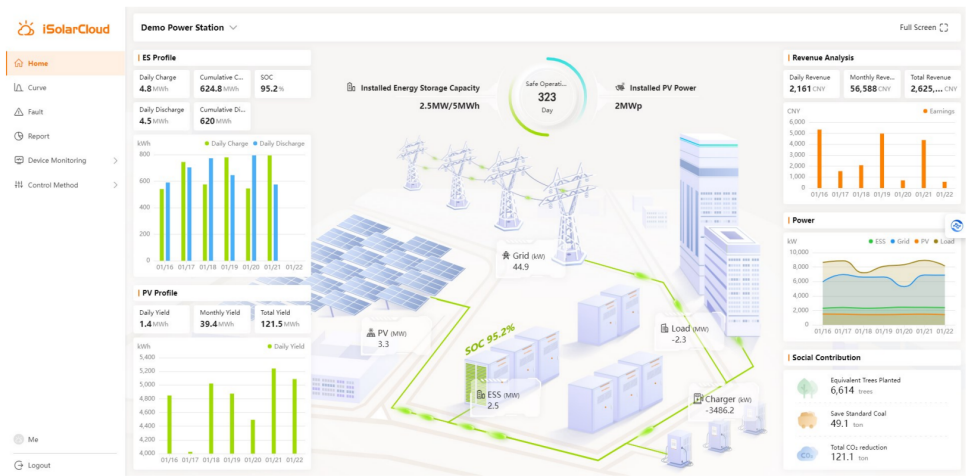

figure 1-11 EMS300CP iSolarCloud Homepage

2 Mechanical Installation

WARNING

During the whole process of mechanical installation, the relevant standards and requirements of the project site must be strictly observed.

2.1 Inspection Before Installation

2.1.1 Deliverables Inspection

Check whether deliverables are complete against the attached packing list.

2.1.2 Equipment Inspection

- Check whether the product you have received matches the order you have placed.
- Inspect the product and its internal components, and make sure there is no damage.
- If the product is equipped with an EMS300CP controller, ensure the gateway meter and electricity meter used with the EMS300CP have been installed before commissioning.

In case of any problem or doubt, contact your transport service provider or SUNGROW in time.

WARNING

- **Proceed with installation only if the equipment is intact without any signs of damage!**

Before installation, ensure that:

- **The product is in good condition, without any damage.**
- **All the components inside the product are intact without any signs of damage.**

2.2 Installation Environment Requirements

2.2.1 Installation Site Requirement

- The climate environment and geological conditions, such as stress wave emission and underground water level, should be fully considered when selecting the installation site.
- The environment around the installation site should be dry and well ventilated.
- There should be no trees around the installation site to prevent branches or leaves blown off by heavy winds from blocking the door or air inlet of the energy storage system.
- The installation site should be away from areas where toxic and harmful gases are concentrated, and free from inflammable, explosive and corrosive materials.

- It is suggested the product be installed in a place away from the residential area. Ensure the distance and noise requirements specified by the local laws and regulations are met. If the requirements cannot be met due to geographical restrictions, use noise mitigation measures. For detailed solutions, consult with the designer or SUNGROW.
- Avoid installing the ESS in dusty environments with a large amount of dust, smoke, or floc. These particles may cling to the air inlets/outlets or heat sink of the ESS, thus impairing its heat dissipation performance or even getting it damaged.
- Avoid installing the ESS in places where corrosive gas or dust may be produced or accumulated, or in places within 30km (20 miles) of saline-alkaline land or pollution-generating industrial complex such as chemical plants and power plants (chemical gas class: 1C1, solid particle level: 1S2).
- Do not install the ESS in environments contaminated with halogen or sulfur pollutants.
- There are no underground facilities at the site.

NOTICE

Do not install the device in an environment with vibration and strong electromagnetic field. Strong-magnetic-field environments refer to places where magnetic field strength measures over 30 A/m.

2.2.2 Foundation Requirements

WARNING

Considering the equipment's heavy weight, before foundation building, perform a thorough inspection on the installation site first (from the aspects of geology, environment, and climate, etc.). Foundation design and construction can be carried out only after confirming that the installation site meets all relevant requirements.

An improperly built foundation may lead to difficulties or troubles in equipment mounting, opening and closing of cabinet doors, and future operation of the equipment. Therefore, the foundation must be designed and constructed in compliance with certain standards, to meet the requirements of mechanical support, cable laying, and future maintenance.

Make sure at least the below requirements are met during foundation building:

- The bottom of the foundation pit must be compacted, filled and made even.
- The foundation should be built in compliance with the foundation drawing provided, or approved, by SUNGROW. The tolerance for the upper surface of the foundation is $\pm 5\text{mm}$.
- The foundation should provide sufficient and effective support for the equipment.
- The equipment should be positioned in a higher place, to protect its base and interior from rain erosion. It is recommended to build a foundation about 300mm higher than the horizontal ground on site.
- Set up a proper drainage system based on the local geological conditions.

- Build a cement foundation with sufficient cross-sectional area and height. The foundation height should be determined by the constructor based on the on-site geological conditions.
- Take cable laying into consideration when building the foundation.



In the process of foundation building, remove the muck immediately after excavation, to avoid affecting the hoist and transport of the equipment.

- Build a platform around the foundation to facilitate future maintenance.
- During the foundation building, reserve sufficient space for the AC side cable trench according to the position and size of the cable inlet and outlet on the equipment, and embed the cable conduit in advance.
- Determine the specifications and quantity of the perforating gun according to the model and quantity of cables used.
- Both ends of each embedded conduit should be temporarily sealed off to prevent the ingress of foreign objects. Otherwise, it may lead to difficulties in wiring.
- After all the cables are connected, seal off the cable inlet and outlet and the connectors with fireproof mud or other suitable materials, to prevent rodents from entering the equipment.



Pre-bury the grounding unit according to the applicable standards of the country/region where the project is located.

2.2.3 Installation Space Requirements

For better heat dissipation and ease of maintenance, it is recommended to reserve sufficient space around the ESS during installation.

NOTICE

The distance here refers to the distance from the wall or other equipment to the ESS cabinet, not to the ESS foundation.

Installation of One ESS

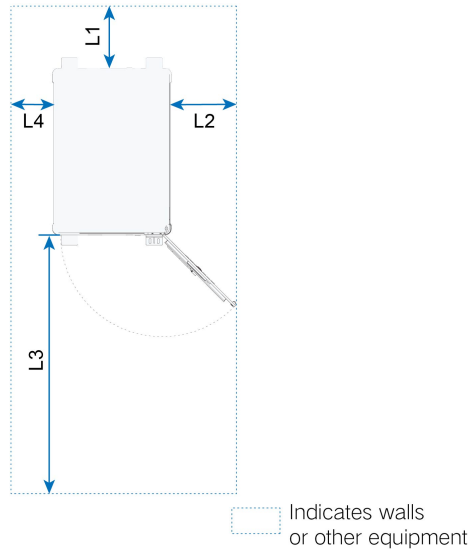

figure 2-1 Space Required for One ESS

Maintenance Item	Space Requirements
Maintenance tooling for non-PACK components	$L1 \geq 300\text{mm}$, $L2 \geq 430\text{mm}$, $L3 \geq 2500\text{mm}$, $L4 = 0$
PACK maintenance tooling	$L1 \geq 300\text{mm}$, $L2 \geq 630\text{mm}$, $L3 \geq 2000\text{mm}$, $L4 \geq 400\text{mm}$

Installation of Multiple ESSs

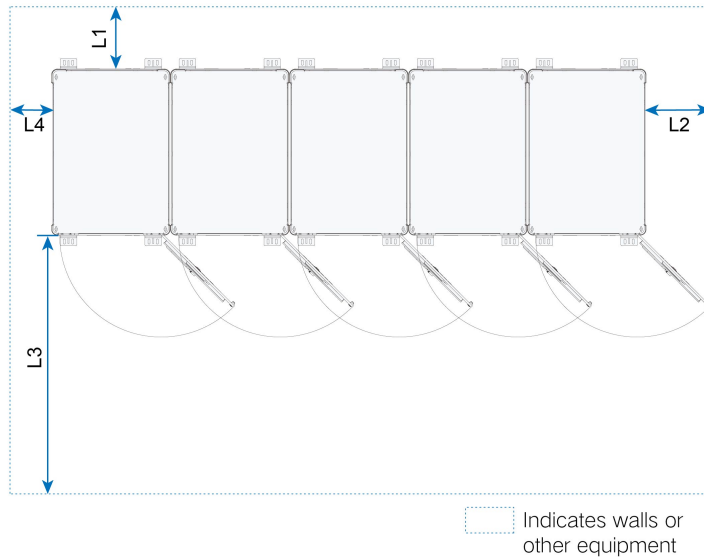

figure 2-2 Space Required for ESSs in One Row

Maintenance Item	Space Requirements
Maintenance tooling for non-PACK components	$L1 \geq 300\text{mm}$, $L2 \geq 430\text{mm}$, $L3 \geq 2500\text{mm}$, $L4 = 0$
PACK maintenance tooling	$L1 \geq 300\text{mm}$, $L2 \geq 630\text{mm}$, $L3 \geq 2000\text{mm}$, $L4 \geq 400\text{mm}$

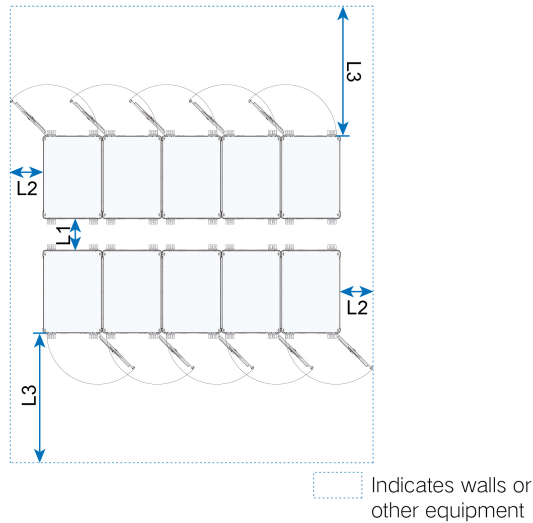

figure 2-3 Space Required for ESSs in Two Rows

Maintenance Item	Space Requirements
Maintenance tooling for non-PACK components	L1≥600mm, L2≥430mm, L3≥2500mm
PACK maintenance tooling	L1≥600mm, L2≥630mm, L3≥2000mm

* The figure is for reference only. The product received may differ.



When arranging the ESS cabinets in two rows, ensure that the two rows are aligned on both sides. Avoid misaligned arrangements to minimize the risk of hindered heat dissipation.

With Obstructions in Heat Dissipation Path

If the ESS is installed indoors or if there are significant obstructions in the air outlet pathway, add ventilation equipment to enhance heat dissipation. The temperature at the air inlet must not exceed 45°C to ensure long-term stable operation of the system.

For indoor installation, ensure that the distance from the top and two sides of the ESS to any obstructions that could hinder heat dissipation, such as walls, meets the following requirements:

- For an ESS with one side against an obstruction, maintain a space of ≥800mm above the cabinet for effective ventilation.

NOTICE

Ensure a ventilation rate of 2500m³/h and a cooling capacity of 7kW at the air outlet on the rear of each ESS cabinet.

NOTICE

Outdoor installations where heat dissipation is significantly compromised by large obstructions above or beside the cabinet should be treated as indoor installations. In such cases, the distance from the cabinet to the obstruction must comply with the same requirements specified for indoor installations.



- Installing the ESS outdoors is recommended, as per the general plant design standards.
- For cabinets installed indoors due to layout constraints, SUNGROW specifies indoor arrangement requirements from the perspective of product design and maintenance only. The owner/EPC shall consider plant-level requirements in these cases.

2.3 Handle with Forklift

The ESS can be moved using a forklift if the ground on the installation site is flat. Forklift pockets are provided at the bottom of the ESS for the insertion of forklift forks.

To move the ESS using a forklift, make sure the below requirements are met:

- The forklift has sufficient load capacity.
- The forks are long enough for moving the equipment.

The forks should be inserted into the forklift pockets at the bottom of the equipment (see the figure below for the positions of the pockets). The depth of the forks inserted into the pockets should be the depth of the pockets.

- Handle, move, and place the ESS slowly and steadily. It is suggested to try a little first before handling, to make sure all requirements are met.
- Position the ESS on a stable surface only, and this place should be free of obstacles or protrusions, with good drainage.

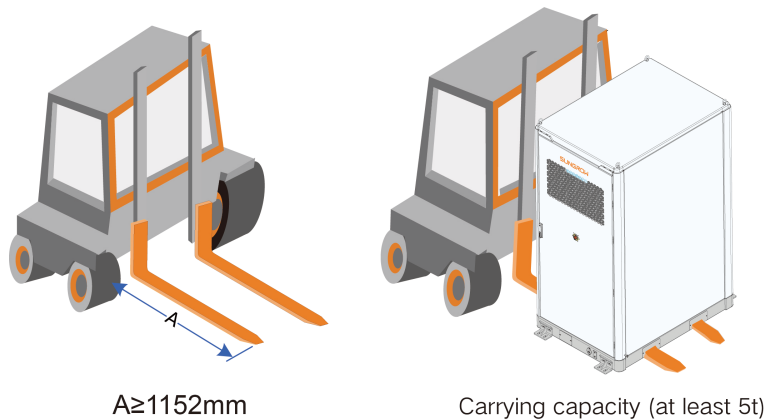

figure 2-4 Handle with Forklift

WARNING

- **Move the ESS using a forklift by the bottom forklift pockets.**
- **Never insert the forklift forks into any position on the equipment else than the bottom pockets.**



The ESS will be delivered with forklift pockets exposed to air. It is suggested to cover the pockets with sealing plates after the installation is completed. The sealing plates are included in the accessories.

2.4 Hoisting and Transport

2.4.1 Precautions

WARNING

- **Perform operation in strict accordance with the safe operation procedure of the crane in the whole process of hoisting.**
- **No one is allowed to stay within 5m to 10m of the operating area. In particular, do not stand anywhere under the crane boom or the equipment that has been lifted up, to avoid personal injuries or death.**
- **In case of severe weather, such as heavy rain, fog, and strong wind, stop the hoisting work immediately.**

During equipment hoisting, make sure at least the following requirements are met:

- It is safe on site.
- The whole hoisting work on site is performed under the guidance of qualified technical persons.
- The slings used must be of sufficient strength for the load to be lifted.

- Make sure the connections of slings are all secure and reliable, and the length of the sling connected to each corner fitting is the same.
- The sling length can be adjusted based on the actual situation on site.
- Ensure the equipment is held steady and does not tilt in the whole process.
- Take all necessary auxiliary measures to ensure the safety of the equipment and the successful completion of the hoisting work.

The figure below shows how the equipment is lifted by the crane. The inner dashed circle in the figure indicates the crane's work zone. While the crane is working, do not stand anywhere in the area of the red solid circle.

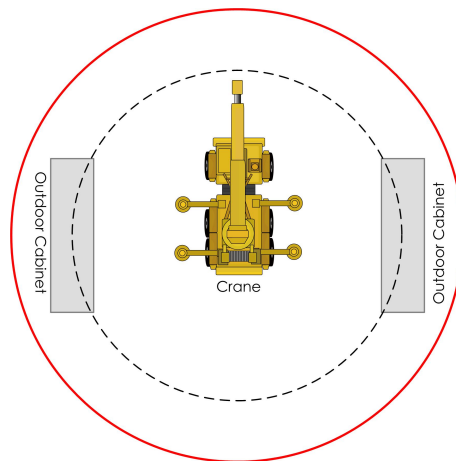

figure 2-5 Crane Operation

2.4.2 Hoisting

Lift the equipment according to the following requirements:

- The equipment should be lifted vertically. Do not drag the equipment along the ground, nor drag it along the top surface of the equipment underneath it. Do not push or pull the equipment along any surface.
- Suspend hoisting when the equipment is lifted 300mm off the supporting surface. Then, check the connection between the slings and the equipment. Continue hoisting only after you have confirmed that the connections are all secure.
- When the equipment is moved to the target position, lay it down gently and steadily. Do not attempt to throw it to place. Make sure it lands vertically.
- The equipment should be positioned on a flat and solid surface with good drainage, free of obstacles or protrusions.
- You may use slings with lifting hooks or U-shaped hooks to lift the ESS. The lifting devices should be connected to the ESS properly.
- Considering on-site conditions, lift the ESS by its four lifting rings, with non-vertical forces applied.



figure 2-6 ESS Hoisting

*The figure shown here is for reference only. The real product may differ.

2.5 ESS Fixing

After moving the ESS to the target position, fix it in place. You can fix the equipment by welding or using L-shaped angle steels.

Fixed by welding

Fix the ESS bottom to the foundation by welding. Apply anti-corrosion treatment to the welding points after welding is completed.

Fixed with L-shaped angle steels

As shown in the figure below, mounting holes for L-shaped angle steels are provided at the bottom of the ESS.

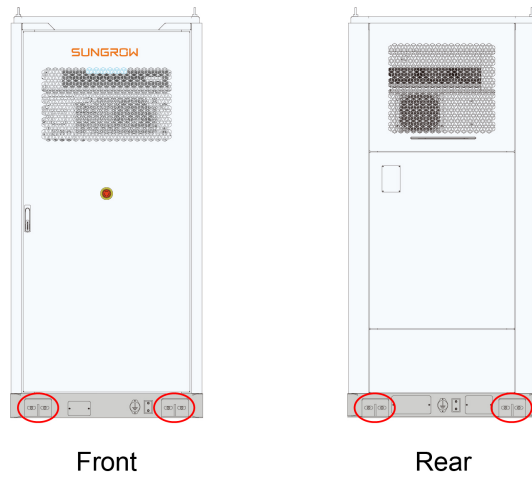

figure 2-7 L-shaped Angle Steels

Installation Tools

Tools that may be used when installing the L-shaped angle steels are as follows:

No.	Name	Source
1	Marker	Not included in the scope of supply
2	Hammer drill	Not included in the scope of supply
3	Angle steel	Included in the scope of delivery
4	M16 expansion bolt	Not included in the scope of supply
5	M16 screw	Included in the scope of delivery

Installation Method

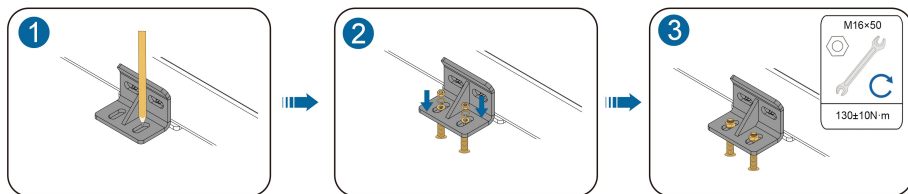

3 Electrical Connection

3.1 Precautions

DANGER

High voltage! Electric shock!

- It is strictly forbidden to directly touch the live parts in the unprotected state!
- Before installation, ensure that the all switches are off.

WARNING

Sand and moisture penetration may damage the electrical equipment in the system, or affect their operating performance!

- Avoid electrical connections during sandstorms or when the relative humidity in the surrounding environment is greater than 95%.
- Perform electrical connection when there is no sandstorm and the weather is fair and dry.

WARNING

- Before wiring, check and ensure that the polarity of all input cables is correct.
- During electrical installation, do not forcibly pull any wires or cables, as this may compromise the insulation performance.
- Ensure that all cables and wires have sufficient space for any bends.
- Adopt the necessary auxiliary measures to reduce the stress applied to cables and wires.
- After completing each connection, carefully check and ensure that the connection is correct and secure.

WARNING

When an external short circuit occurs in the RACK circuit and the switch box fuse produces a protective action, the fuse and the two DC contactors must be replaced at the same time.

3.2 Electrical Connection Overview

The wiring diagram of the ESS is shown below:

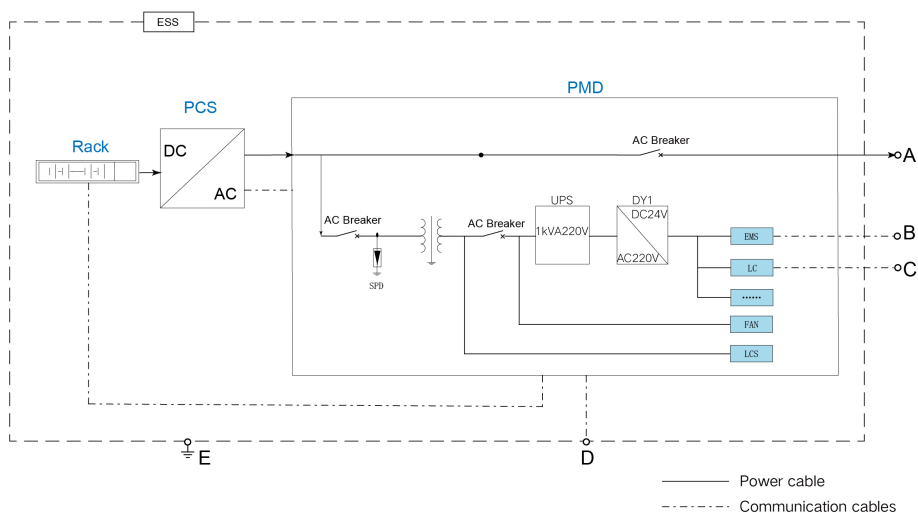

figure 3-1 Wiring Diagram

table 3-1 Interface Description

No.	Name	*Recommended cable specifications
A	AC output port	3×95mm ² /copper wire 3×150mm ² /aluminum wire
B	**EMS communication port (connection port 2)	2×0.5mm ² shielded twisted-pair cable
C	LC communication port (connection port 1)	2×0.5mm ² shielded twisted-pair cable
D	Ethernet communication port	CAT5A network cable
E	Grounding point	70mm ² –95mm ² yellow-green cable or grounding flat steel

*The above cables are not included in the scope of delivery and should be prepared separately.

**The EMS is optional.

⚠ WARNING

- **Electrical connections must all be performed in strict accordance with the wiring diagram.**
- **Electrical connections must all be performed when the equipment is completely voltage-free.**

⚠ WARNING









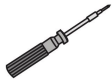

Operations related to the electrical connection must only be performed by qualified electrical engineers, all in compliance with the “Safety Precautions” specified in this manual. SUNGROW shall not be held liable for any personal injury or property damage arising from failure to follow the safety instructions.

NOTICE

- Installation and wiring of the ESS must conform to the applicable standards or regulations in the country/region where the project is located.
- Wiring or installation not in accordance with the relevant instructions provided in this manual may result in equipment or system failure, which will not be covered by the warranty.

3.3 Preparation Before Wiring

3.3.1 Prepare Installation Tools

Item	Name and Graphics		
Installation tool			
	Torque screwdriver	Wire stripper	Hydraulic pliers
			
	Heat gun	Multimeter	Screwdriver
			
	Torque wrench		
Protective tools			
	Safety gloves	Goggles	Safety shoes
			
	Protective clothing		

3.3.2 Open Cabinet Door

Open the cabinet door before wiring.

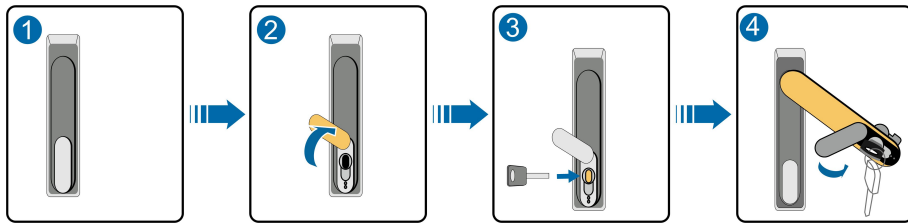

figure 3-2 Open the Front Door

Step	Description
1	Door locked
2	Move the cover above the lock hole
3	Insert the door key and turn it clockwise
4	Rotate the handle clockwise to the position shown in the figure to open the front door

3.3.3 Prepare Cables

⚠ DANGER

Before electrical connection, check and ensure that the cables are all intact and well-insulated. Poor insulation or cable damage may result in safety hazards. If necessary, replace the cable immediately.

The cables must meet the following requirements:

- The current carrying capacity of the cable meets requirements. Factors affecting the current carrying capacity of a conductor include but are not limited to:
 - Environmental conditions;
 - Type of the insulation material of the conductor;
 - Cabling method;
 - Material and cross-sectional area of the cable.
- Select cables with a proper diameter according to the maximum load, and the cables should be long enough.
- Ensure that all cables and wires have sufficient space for any bends.
- During electrical connection, do not forcibly pull any wires or cables, as this may diminish their insulation performance.
- All DC input cables must be of the same specifications and materials.
- AC output cables of three phases must be of the same specifications and materials.
- Only flame retardant cables can be used.

- Keep a sufficient distance between the cables and the heat-generating components, to prevent the cable insulation layer from aging or getting damaged due to high temperature.
- After completing each connection, carefully check that the connection is correct and secure.
- Adopt necessary auxiliary measures to reduce the stress applied to cables and wires.
- Select cables with appropriate cross-sectional areas, according to the actual environmental conditions for heat dissipation of the cables laid on-site.
- Select communication cables equipped with corresponding shielding protection features according to the requirements of SUNGROW.
- Secure the power cables and the communication cables separately. Ensure a minimum space of 10cm between the lines of strong and weak electricity to avoid electromagnetic interference.

NOTICE

- **The cables used should comply with requirements of local laws and regulations.**
- **The cable color in figures in this manual is for reference only. Please select cables according to local standards.**

Crimp terminal

Crimp OT/DT terminals

Follow the steps shown below to crimp terminal.

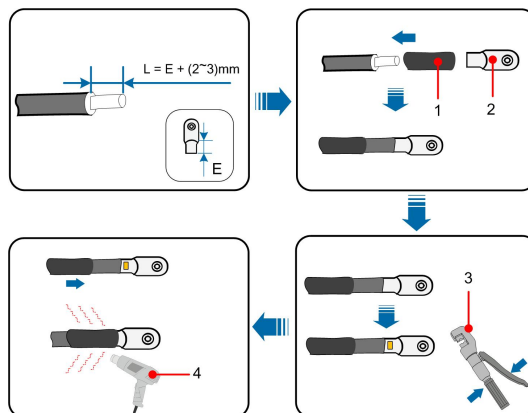

No.	Description	No.	Description
1	Heat shrink tubing	2	OT/DT terminal
3	Hydraulic pliers	4	Heat gun

3.3.4 Copper Wire Connection

When copper cables are selected, the connection sequence of wiring parts is shown in the following figure.

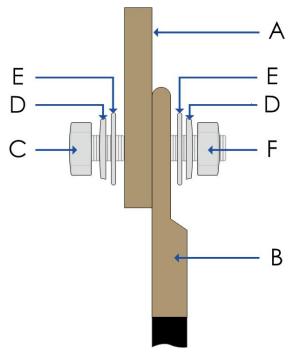

figure 3-3 Copper cable terminal connection sequence

No.	Name	No.	Name
A	Copper bus bar	D	Spring washer
B	Copper connection terminal	E	Flat washer
C	Bolt	F	Nut

NOTICE

Bolt fastening should be firm and reliable, and the exposed wire buckle should not be less than 2 buckles.

3.3.5 Aluminum Wire Connection

When the aluminum wires are selected, a copper-to-aluminum adapter terminal is needed as shown below:

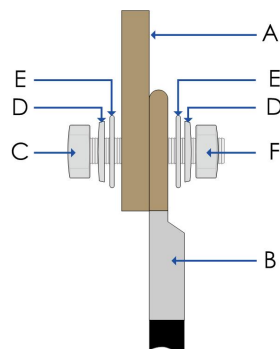

figure 3-4 Copper-to-aluminum adapter terminal connection

No.	Name	No.	Name
A	Copper bus	D	Spring washer
B	copper-toaluminum adapter terminal	E	Flat washer
C	Bolt	F	Nut

NOTICE

Bolt fastening should be firm and reliable, and the exposed wire buckle should not be less than 2 buckles.

3.3.6 Cable Inlet Design

Cables connecting the external devices to the ESS can be led through the cable inlet at the bottom of the ESS.

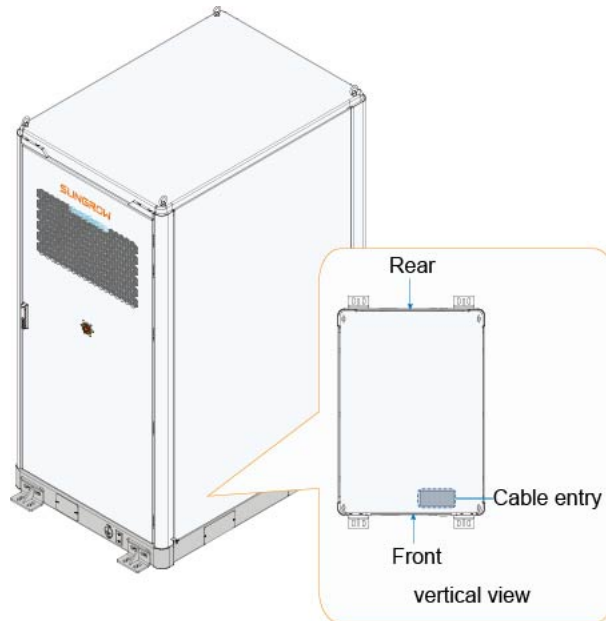

figure 3-5 Cable Inlet

3.4 Ground Connection**NOTICE**

Grounding must be completed by strictly following the applicable local standards and regulations.

NOTICE

- **Before grounding, clean the periphery of the threaded port of the grounding point and the surface of the grounding point, to ensure reliable grounding.**
- **After grounding, apply anti-corrosion treatment for the entire grounding area.**

Overview

Grounding can be made in the following two ways: welding a grounding flat steel, or connecting a grounding cable. For the location of the grounding point, see “**ESS External Design**”.



用户现场安装的设备（如无线路由器）需要就近接地。

Grounding Flat Steel (Recommended)

Remove the protective tape from the grounding point and weld the hot-dip galvanized flat steel to the grounding point (the area where the flat steel and the ESS are joined together should be 40mm x 70mm). Spray paint the whole fixing area after completing welding.

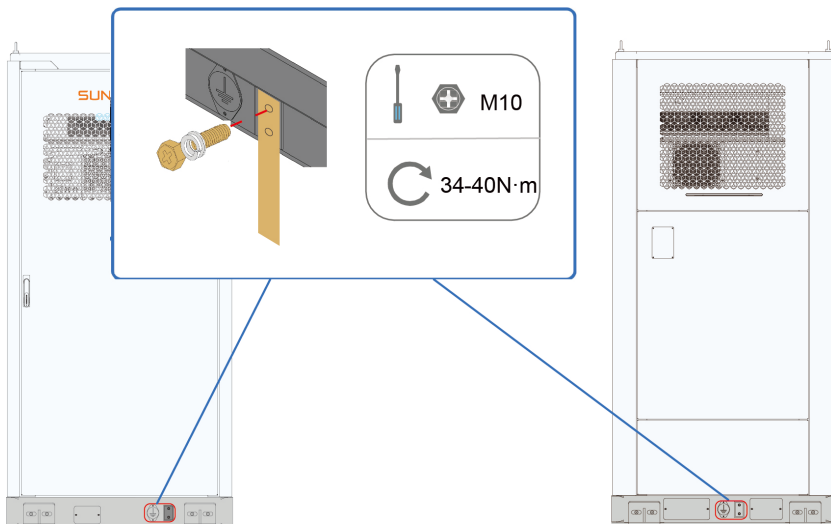

figure 3-6 ESS Grounding Diagram

*The figure is for reference only and the actual product shall prevail.

Grounding Cable

Use a 70 mm²–95 mm² copper grounding cable to connect the target grounding point to the grounding point on the ESS properly and reliably (the grounding point is covered with protective tape upon delivery, which should be removed before wiring).

Crimp the DT terminal. For details, see “[3.3.3 Prepare Cables](#)”. Secure the DT terminal to the wiring hole with an M10 bolt at a tightening torque of 34–40N·m.

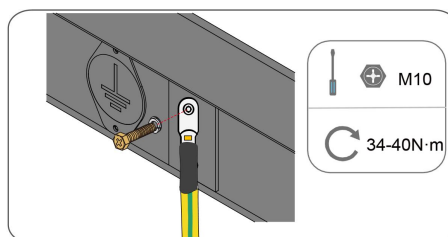

*The figure is for reference only and the actual product shall prevail.

Carry out external ground connection in compliance with the actual on-site conditions and the instructions by the plant staff.

Measure the ground resistance after completing the grounding. Make sure the resistance does not exceed 4Ω .



The specific ground resistance should comply with the applicable national/local standards and regulations.

3.5 AC Connection

3.5.1 Safety Precautions

WARNING

Accidental touching of live terminals can cause fatal electric shock!

- **Ensure that the AC/DC switches of the PCS are open, and that the wiring terminals are dead.**
- **Connecting to the power grid must be approved by the relevant department and comply with all power-related safety instructions and specifications.**

WARNING

- **When connecting to the AC grid, disconnect the upstream AC side circuit breaker to ensure that there is no voltage at the contact terminals.**
- **Connect to the grid only if approved by the utility grid and all relevant safety instructions are followed.**
- **The AC output is not grounded inside the device.**
- **The DC and AC circuits are isolated from the enclosure. If required by the relevant national electrical codes, the installer is required to connect the system.**

3.5.2 AC Output Wiring

Step 1 Switch off the upstream AC circuit breaker and measure with a multimeter to ensure no voltage is present at the terminals.

Step 2 Lead the cable to the AC wiring area inside the cabinet through the cable inlet.

Step 3 Make sure the AC cables are connected properly in the correct positions.

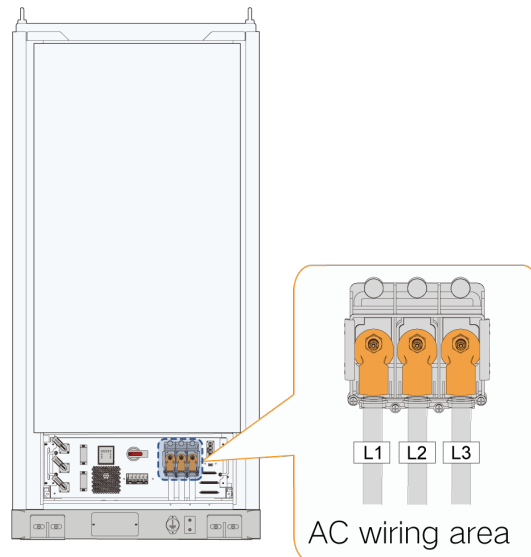

figure 3-7 AC Wiring Area

Step 4 Strip the protective layer of the cables using wire strippers to expose the copper cores.

Step 5 Crimp the OT terminal. For details, see .

Step 6 Secure the OT terminals to the wiring holes with M12 bolts at a tightening torque of 40 N·m (for detailed wiring instructions, please refer to "[3.3.4 Copper Wire Connection](#)" and "[3.3.5 Aluminum Wire Connection](#)").

Step 7 Pull the cables backward gently after wiring to ensure the cables are long enough.

Step 8 Close the protective cover for terminals, fasten the protective buckles on both sides, and tighten the four screws.

NOTICE

- **Perform wiring in strict accordance with the correct phase sequence.**

-- End

3.6 Communication Wiring

The ESS cabinet houses the ports for external Ethernet communication, LC communication, EMS communication, and FSS power supply wiring.

3.6.1 Ethernet Communication

Positions of the Ethernet communication ports are shown in the figure below.

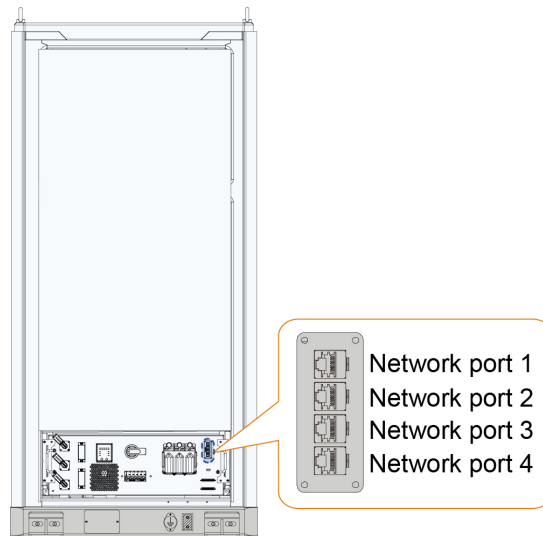
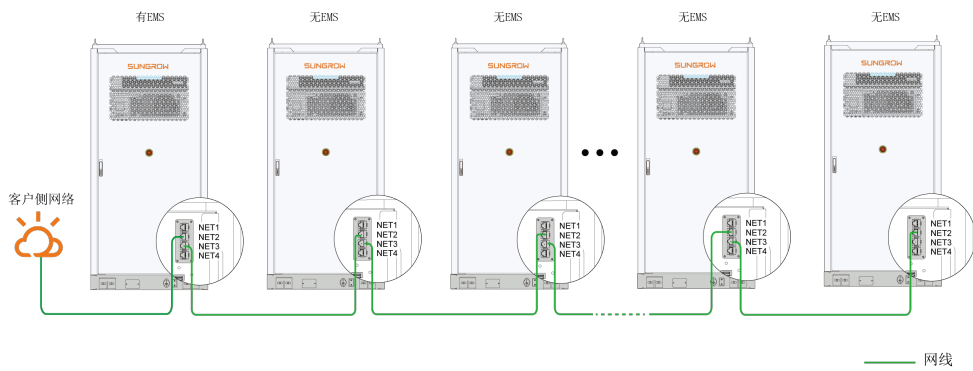

figure 3-8 Communication Ports

table 3-2 Port Description

Name	Description
NET1	Connected to PCS (the internal wiring has been completed)
NET2	Used for inter-cabinet networking
NET3	Used for inter-cabinet networking
NET4	Reserved for 0.25C system networking



- The system supports up to 10 ESS cabinets in parallel. The cabinet with an EMS is accessed to the customer network and connected hand-in-hand with other cabinets that do not have EMS.
- Users can check the label on the power distribution box to understand whether the product is equipped with an EMS controller.
- NET2 and NET3 are used for inter-cabinet networking and no distinction is made between them.

figure 3-9 Inter-cabinet Networking

3.6.2 EMS/LC/External FSS Power Supply Wiring

The CONN1, CONN2, and CONN3 on the power distribution box house the terminals for EMS, transformer, ATS, LC, and external FSS power supply wiring.

Positions of CONN1, CONN2, and CONN3 are shown in the figure below.

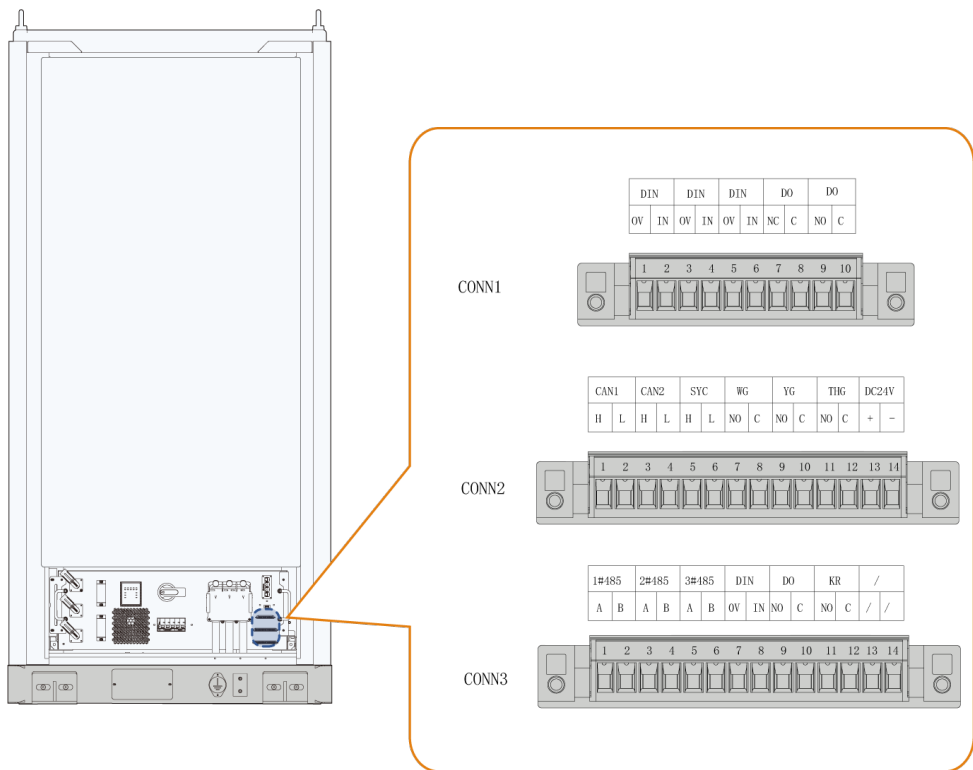

figure 3-10 Communication Ports

Port	Point	Usage
CONN1	CONN1-1/2	LC "transformer cabinet fault" dry contact input (DIN10)
	CONN1-3/4	LC reserved dry contact input (DIN15)
	CONN1-5/6	PCS reserved on/off-grid switching input (connected to ATS)
	CONN1-7/8	LC "transformer cabinet fault linkage control" DO output (DO1)
	CONN1-9/10	LC reserved DO output (DO2)
CONN2	CONN2-1/2	CMU communication wiring, reserved for maintenance
	CONN2-3/4, CONN2-5/6	PCS parallel communication wiring
	CONN2-7/8	FSS "heat detector triggered" dry contact output
	CONN2-9/10	FSS "smoke detector triggered" dry contact output
	CONN2-11/12	FSS "gas released" dry contact output

Port	Point	Usage
	CONN2-13/14	24V power supply for ATS
	CONN3-1/2, CONN3-3/4, CONN3-5/6	EMS RS485 communication
	CONN3-7/8	EMS dry contact input (DI1)
CONN3	CONN3-9/10	EMS DO output (DO1)
	CONN3-11/12	FSS "flammable gas detector" dry contact output
	CONN3-13/14	Reserved



If there is no transformer cabinet, CONN1 1–2/7–8 do not need to be wired.
 If there is no ATS, CONN1 5–6 and CONN2 13–14 do not need to be wired.
 EMS is optional. If no EMS is equipped, CONN3 1–10 are invalid.

Diagram of Networking Between Off-grid ST200CS and Transformer Cabinet

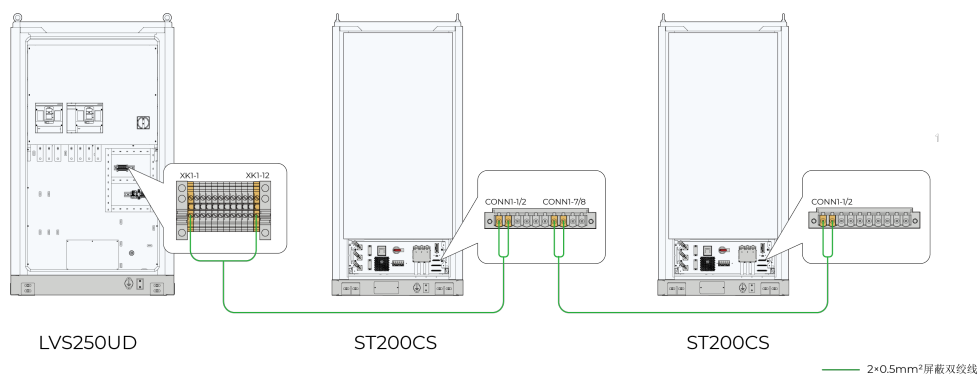

- Equipping one transformer for every two ST200CS cabinets is recommended to achieve the maximum operation efficiency.
- Connect any one of the two ST200CS cabinets to the transformer.

3.7 Post-wiring Work

Inspect the wirings thoroughly and carefully after all electrical connections have been completed. In addition, perform the following operations:

- Check that there is no obstruction or blockage by foreign objects at the air inlet and outlet.
- Seal off the cable inlet and outlet of the ESS cabinet, by filling the gap around them with fire-/water-stop materials.

⚠ WARNING

- **Moisture may get in if the product is not properly sealed.**
- **Rodents may get in if the product is not properly sealed.**

Lock the cabinet door

Step 1 Mount back the protective cover for the wiring area, by completing the steps for removal (see "Open Cabinet Door") in reverse.

Step 2 Lock the cabinet door and pull out the key.

-- End

NOTICE

After closing the cabinet door, make sure the sealing strip around the door does not curl.

4 Battery Connection

4.1 Precautions

Always follow the safety instructions in this manual. In order to avoid personal injury and property damage that may occur during installation or operation, and extend the service life of this product, please carefully read all safety instructions.

Improper or incorrect use may result in:

- A threat to the life and personal safety of the operator or third parties;
- Damage to the energy storage system or other property of the operator or third party.



- The safety precautions in this manual do not cover all specifications to be followed, and all operations should be performed based on the site conditions.
- SUNGROW shall not be liable for any loss arising from failure to follow the safety precautions in the manual.

WARNING

- **While installing the device with hazardous voltage, follow relevant regulations and local installation safety guidelines.**
- **Please observe the regulations on the correct use of tools and personal protective equipment.**
- **All connections must be carried out with distinctive guidance. Any guess and ambiguous attempts must be prohibited.**
- **Tools with an insulating protective coating must be used.**

- Connecting cables should meet the voltage and current requirements.
- All connectors must be safe and reliable to avoid loosening or virtual contact. They must be corrosion-resistant, wear-resistant and shock-proof.
- All connections must comply with the requirements of relevant national standards to prevent arc discharge in any form.
- The connections of internal batteries must be equipped with anti-vibration and antiloosening devices. Temperature, voltage and current sensors must be connected safely and reliably, to prevent loosening, ageing and extrusion. All sensor cables must be free of metal exposure.
- Any type of short circuit should be prevented in the connection process.
- Operators must use this product with personal protective equipment.

- All connections must be carried out with distinctive guidance. Any guess and ambiguous attempts must be prohibited.
- Key connections must be correct, reliable (without loosening) and in good contact, without short-circuits.
- All the finished connections must be measured and confirmed one by one.
- All connections must not be in contact with the casing or other components or shortcircuited.
- If there are other uncertain factors, please consult the after-sales technicians of SUNGROW before any operation.

4.2 Battery Wiring

Tools

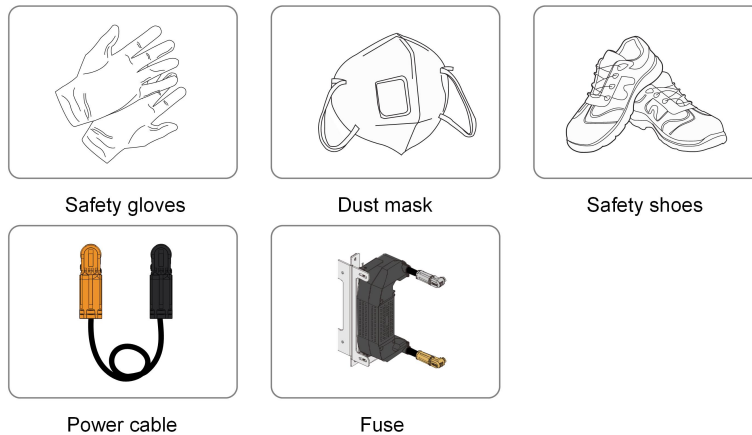

figure 4-1 Installation Tools

Step 1 Before connecting the power cable, put on insulated shoes and safety gloves. Before connecting the power cable between PACKs, disconnect the wiring between the PACK and the PCS first.

Step 2 Install the fuse. Open the cabinet door, and remove the sponge separators that hold the fuse plugs.

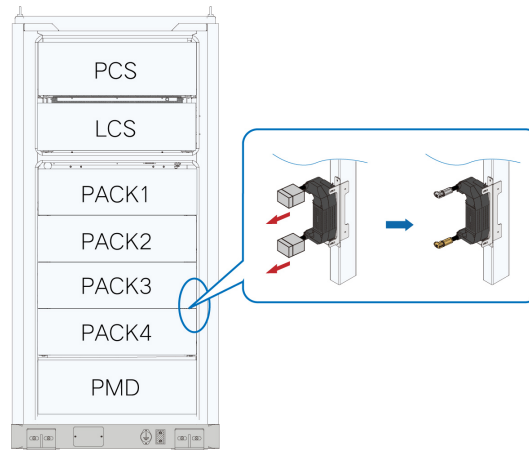

figure 4-2 Position of Fuse

Step 3 Insert the plugs that come with the fuse into the PACK bases properly.

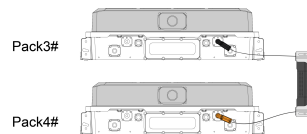

figure 4-3 Insert Fuse Plugs into PACK Bases

WARNING

When the aviation plug is connected in place, you will hear a "click". Please make sure the connection is secure.



- Insert the positive aviation plug into the positive on the PACK base, and the negative plug into the negative on the base. Orange indicates positive, and black indicates negative. When the aviation plug is connected in place, you will hear a "click".
- When connecting the power cables, you can adjust the position of the fuse properly.

Step 4 Connect the power cables between the PCAKs. The positive connector of the power cable between the PACKs has been secured on the RACK, and the negative connector is secured on the side bracket with the quick-connect clip and cable tie.

WARNING

When the aviation plug is connected in place, you will hear a "click". Please make sure the connection is secure.

NOTICE

When connecting the power cable between the PACKs, take down the negative connector of the power cable from the quick-connect clip on the side bracket, and then insert it into the negative on the base.

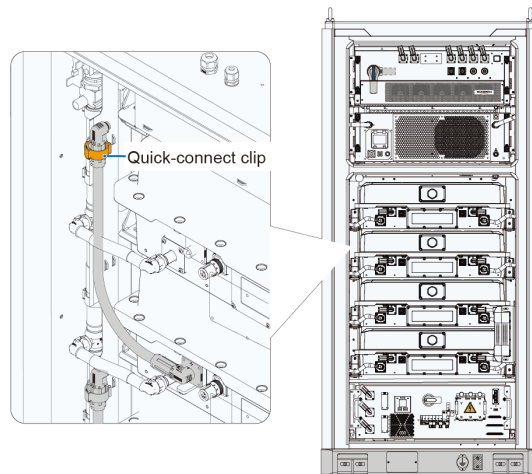
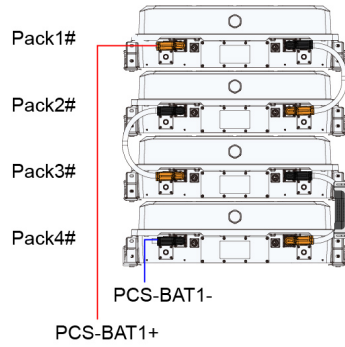

figure 4-4 Quick-connect Clip

- 1 Connect the BAT- of Pack1# to the BAT+ of Pack2#;
- 2 Connect the BAT- of Pack2# to the BAT+ of Pack3#.

Step 5 Connect the power cable between the PACK and the PCS:

- 1 Connect the BAT+ of Pack1# to the BAT+ of PCS;
- 2 Connect the BAT- of Pack4# to the BAT- of PCS.

**figure 4-5** PACK Wiring Diagram**⚠ WARNING**

When the aviation plug is connected in place, you will hear a "click". Please make sure the connection is secure.

-- End

5 Powering up and Shutdown

5.1 Powering up

WARNING

- The equipment can only be put into operation after confirmation by a professional and approval of the local energy department.

WARNING

- For equipment that has a long shutdown time, inspect it thoroughly and carefully and make sure all the indicators meet the relevant requirements before powering up.

5.1.1 Inspection Before Powering up

Before powering up the equipment, check the following items carefully.

- Check whether the wiring is correct.
- Check whether the protective covers inside the equipment are installed firmly.
- Check whether the emergency stop button is released.
- Check and ensure that there is no grounding fault.
- Check whether the AC and DC voltages meet startup conditions and ensure that there is no over-voltage with a multimeter.
- Check and ensure that no tools or components are left inside the equipment.
- Check all air inlets and outlets for blockage.
- If the equipment has been stored for more than six months, the top radiator fan should be checked for proper rotation, noise or stalling before powering up.

5.1.2 Powering on Steps

Inspect the equipment thoroughly before powering it on. The equipment can only be powered on after all the inspection items are confirmed to meet the requirements.

- The power and communication wiring of the ESS have been completed.
- The outdoor temperature is in the range of -30°C to 50°C.



It is not recommended to power on the equipment at temperatures below -30°C. If the temperature is too low, it will take 24 hours or more for the system to heat the cells. During this period, the system cannot operate normally.

- Step 1** PCS: Set the DC-side load switch of the PCS to "ON". Make sure the emergency stop button on the cabinet is in the reset state.
- Step 2** Turn on the QF1 (main AC switch) on the panel to power the AC side of the system.
- Step 3** Turn on the Q1 (auxiliary AC switch) on the panel to power on the auxiliary power supply.
- Step 4** Turn on the Q2 (UPS switch) on the panel, and press the power button on the UPS. The system auxiliary power supply will start working (devices including the switch, LC, and fans have all been powered on).
- Step 5** Start up the system through the control software.

NOTICE

If the cabinet is equipped with a liquid cooling unit, check the status of the circuit breakers inside the liquid cooling unit. Close the circuit breaker that has not been closed.

-- End

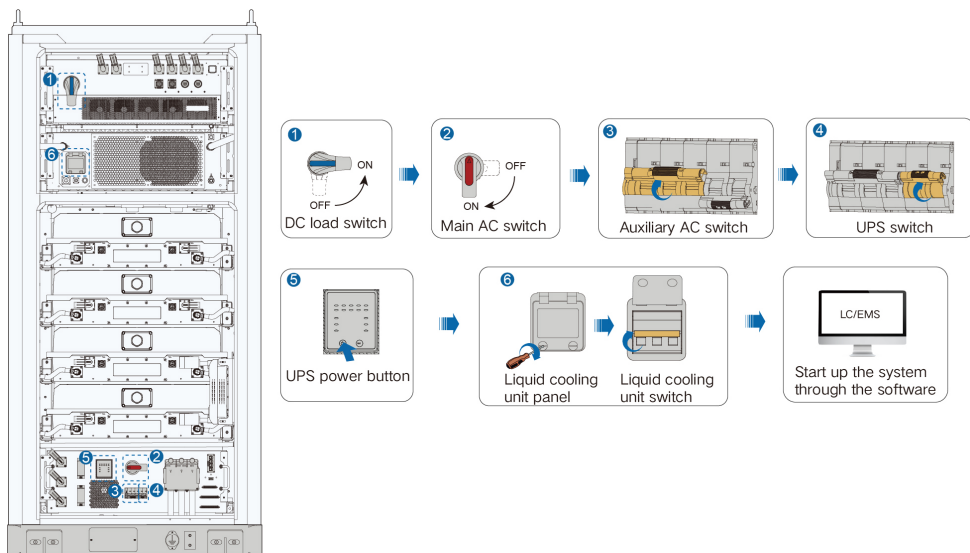

figure 5-1 Powering on Steps



- Auxiliary power supply supplies power to devices such as switches, LCs, and fans.
- The liquid cooling unit may have been closed before leaving the factory, and when powered on, only the closing status needs to be checked.

5.2 Shutdown

5.2.1 Planned Shutdown

Planned shutdown refers to an interruption to the equipment operation that is scheduled in advance for overhaul, test, or maintenance.

Shut the system down via the control software, and switch off the battery relay (in case of an emergency, you can press the emergency stop button on the cabinet).

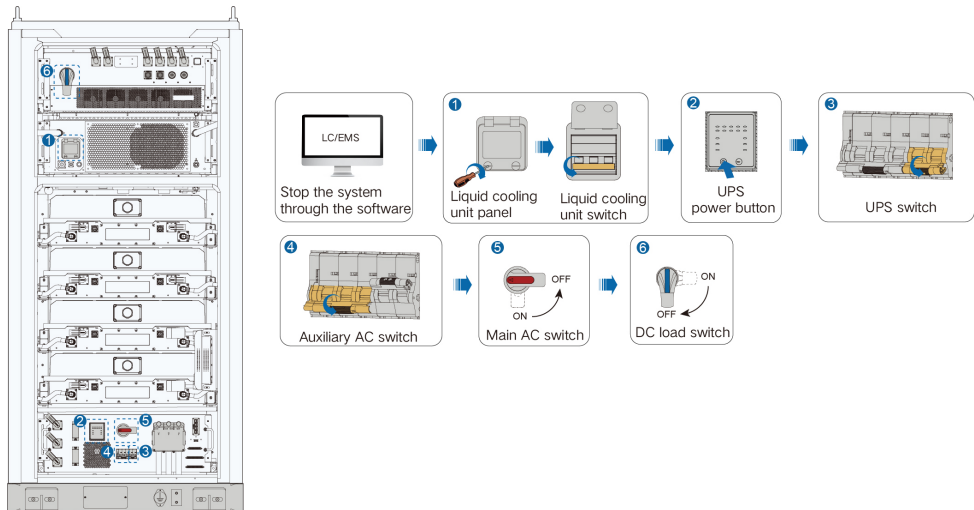

figure 5-2 Powering off Steps

⚠ DANGER

Before performing operation on the AC wiring terminals, be sure to turn off the upstream switches of the ESS first.

Test the voltage after the system self-discharge is completed.

5.2.2 Emergency Shutdown

Contact the local fire department in case of an emergency.

6 Troubleshooting

In case of anything abnormal with the ESS, it is suggested to perform troubleshooting by referring to the troubleshooting methods mentioned in the LC300 user manual first.

For more information, please refer to the below documents:

Document	QR Code
LC300 User Manual	

If the problem persists or there are any other questions, please contact SUNGROW. It would be helpful if you could provide the below information:

- Model and S/N of the ESS and its internal device;
- Fault information and a brief description of the fault;
- A photo of the fault, if possible.

7 Appendix

7.1 Abbreviations

Abbreviation	Definition
B	
BM	Battery Module (or PACK)
BC	Battery Cluster (or RACK)
BMU	Battery Management Unit
BCMU (CMU)	Battery Cluster Management Unit (CMU for short)
BSMU (SMU)	Battery System Management Unit (SMU for short)
BMS	Battery Management System
BSC	Battery System Controller
BCP	Battery Collection Panel. Battery DC inputs are combined into the BCP DC copper bar, and connected to the PCS DC side through the copper bar on the other side of the BCP.
BSP	Battery Power Supply Panel. It is used as an auxiliary power supply for the components inside the battery, such as lighting, FSS, etc.
D	
DC/DC	DC/DC Converter
L	
LC	Local Controller
P	
PCS	Power Conversion System
S	
SCADA	Supervisory Control and Data Acquisition System
S/G	Switch Gear
SOC	State Of Charge
SOH	State Of Health

7.2 Technical Data

Product Model	ST225kWh-110kW-2h
Battery Side	
Cell Type	LFP
System Battery Configuration	256S1P
Rated Battery Capacity	229kWh
Battery Voltage Range	691.2V–934.4V
PCS Side	
Rated Output Power	110kW
Total Harmonic Distortion (THD)	≤3% (at rated power)
DC Component	≤0.5% (at rated power)
Rated Grid Voltage	400V
Grid Voltage Range	340V–440V
Rated Grid Frequency	50Hz
Grid Frequency Range	45Hz–55Hz
System Parameters	
*Dimensions (Width * Height * Depth)	1150 * 2450 * 1610 mm
*Weight	Approx. 2900kg
Max. Round-trip Efficiency	≥87%
IP Rating (Battery Compartment)	IP55
Auxiliary Power Supply	FSS: Internal or external auxiliary power supply (optional); others: internal auxiliary power supply
Corrosion Protection	C3 (or C5, optional)
Operating Humidity Range	0–95% (non-condensing)
Operating Temperature Range	-30 to 50°C (derate at >45°C)
Max. Operating Altitude	3000m
Cooling Method	Intelligent liquid cooling
Fire Suppression System	Flammable gas detector, smoke detector, heat detector, alarm sounder, aerosol fire extinguishing system, backup water-based fire extinguishing system

Product Model	ST225kWh-110kW-2h
Communication	Ethernet
Communication Protocol	Modbus TCP

*The technical data is for reference only, please refer to the information on the nameplate of the product.

7.3 Tightening Torques

To avoid poor contact caused by the loosening of copper cable lugs due to stress, and to prevent heat or even fire due to increased contact resistance, make sure to tighten the screws on the cable lugs at the recommended torques:

Bolt	Torque(N·m)	Bolt	Torque(N·m)
M3	0.7–1	M8	18–23
M4	1.8–2.4	M10	34–40
M5	4–4.8	M12	60–70
M6	7–8	M16	119–140

*Torque values listed in the table are intended for the bolt and nut assembly, and do not apply to riveted nuts or riveted screws, etc. The torque to be adopted should depend on the actual situation.

**Secure the cable at a proper point to reduce the stress on the cable lug.

7.4 Quality Assurance

When product faults occur during the warranty period, SUNGROW ENERGY STORAGE TECHNOLOGY CO., LTD.(SUNGROW) will provide free service or replace the product with a new one.

Evidence

During the warranty period, the customer shall provide the product purchase invoice and date. In addition, the trademark on the product shall be undamaged and legible. Otherwise, SUNGROW has the right to refuse to honor the quality guarantee.

Conditions

- After replacement, unqualified products shall be processed by SUNGROW.
- The customer shall give SUNGROW a reasonable period to repair the faulty device.

Exclusion of Liability

In the following circumstances, SUNGROW has the right to refuse to honor the quality guarantee:

- The free warranty period for the whole machine/components has expired.
- The device is damaged during transport.

- The device is incorrectly installed, refitted, or used.
- The device operates in harsh conditions beyond those described in this manual.
- The fault or damage is caused by installation, repairs, modification, or disassembly performed by a service provider or personnel not from SUNGROW.
- The fault or damage is caused by the use of non-standard or non-SUNGROW components or software.
- The installation and use range are beyond stipulations of relevant international standards.
- The damage is caused by unexpected natural factors.

For faulty products in any of above cases, if the customer requests maintenance, paid maintenance service may be provided based on the judgment of SUNGROW.

7.5 Contact Information

In case of questions about this product, please contact us.

We need the following information to provide you the best assistance:

- Model of the device
- Serial number of the device
- Fault code/name
- Brief description of the problem

For detailed contact information, please visit: <https://en.sungrowpower.com/contactUS>

