

SolaX Meter

M1-40/M3-40/M3-40-Dual

User Manual

Version 0.0

www.solaxpower.com



eManual in the QR code or at <http://kb.solaxpower.com/>

STATEMENT

Copyright

Copyright © SolaX Power Network Technology (Zhejiang) Co., Ltd. All rights reserved.

No part of this manual may be reproduced, transmitted, transcribed, stored in a retrieval system, or translated into any language or computer language, in any form or by any means without the prior written permission of SolaX Power Network Technology (Zhejiang) Co., Ltd.

Trademarks



SOLA X and other symbol or design (brand name, logo) that distinguishes the products or services offered by SolaX has been trademark protected. Any unauthorized use of the above stated trademark may infringe the trademark right.

Notice

Please note that certain products, features, and services mentioned in this document may not be within the scope of your purchase or usage. Unless otherwise specified in the contract, the contents, information, and recommendations presented in this document are provided "as is" by SolaX. We do not provide any warranties, guarantees, or representations, whether express or implied.

The content of the documents is reviewed and updated as needed. However, occasional discrepancies may occur. SolaX retains the right to make improvements or changes in the product(s) and the program(s) described in this manual at any time without prior notice.

The images included in this document are solely for illustrative purposes and may differ based on the specific product models.

For more detailed information, kindly visit the website of SolaX Power Network Technology (Zhejiang) Co., Ltd. at www.solaxpower.com.

SolaX retains all rights for the final explanation.

About This Manual

Scope of Validity

This manual is an integral part of SolaX meters. It describes the installation, electrical connection, parameter settings and troubleshooting of the products. Please read it carefully before operating.

This manual is valid for the following meter models:

- M1-40
- M3-40
- M3-40-Dual

Model description

M1/M3-40-Dual



No.	Value	Description
1	M	Abbreviation for meter
2	<ul style="list-style-type: none">• 1• 3	<ul style="list-style-type: none">• 1: Single phase• 3: Three phase
3	40	Rated input current
4	Dual	Supports dual circuits



Target Group

The installation, electric connection and parameter settings can only be performed by qualified personnel who:

- Are licensed and/or satisfy state and local regulations.
- Have good knowledge of this manual and other related documents.

Conventions

The symbols that may be found in this manual are defined as follows.

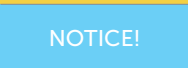
Symbol	Description
 DANGER	Indicates a hazardous situation which, if not avoided, will result in death or serious injury.
 WARNING	Indicates a hazardous situation which, if not avoided, could result in death or serious injury.
 CAUTION!	Indicates a hazardous situation which, if not avoided, could result in minor or moderate injury.
 NOTICE!	Provides tips for the optimal operation of the product.

Change History

Version 0.0 (2023-08-09)

Initial release

Table of Contents

- 1 Safety 1
- 2 Product Overview 2
 - 2.1 Introduction..... 2
 - 2.2 Highlights 2
 - 2.3 Appearance 3
- 3 Typical Networking Diagrams 6
- 4 Unpacking and Inspection 13
 - 4.1 Unpacking..... 13
 - 4.2 Scope of Delivery..... 13
- 5 Cable Connection..... 17
 - 5.1 Cable Requirements 17
 - 5.2 Connection Procedure 18
 - 5.2.1 Power Cable Connection..... 18
 - 5.2.2 CT Cable Connection..... 20
 - 5.2.3 Communication Cable Connection..... 21
- 6 Mechanical Installation 23
- 7 LCD Display 24
- 8 Parameter Setting 30
 - 8.1 Parameter Description 30
 - 8.2 Setting Procedure..... 31
- 9 Troubleshooting 34
- 10 Technical Data 35
- 11 Appendix 36

1 Safety

The Meter is well designed and tested to meet applicable state and international safety standards. As an electrical and electronic equipment, safety precautions must be observed and followed during the installation and electric connection to reduce the risk of personal injury and device damage.

Before installing the device, carefully read, fully understand and strictly follow the detailed instruction of the *User Manual* and other related regulations. The safety instructions in this document are only supplements to local laws and regulations.

SolaX shall not be liable for any consequences caused by the violation of the installation, and operation regulations specified in this document, including, but not limited to:

- Device damage due to force majeure, such as earthquake, flooding, thunderstorm, lighting, fire hazard, volcanic eruption and overvoltage
- Device damage due to human causes
- Failure to follow the operation instructions and safety precautions on the product and in this document
- Installation and use under improper environment or electrical condition
- Unauthorized modifications to the product or software
- Use of incompatible inverters or devices

2 Product Overview

2.1 Introduction

The three meter models are designed for electricity monitoring and power metering both at home and in business scenarios. They can accurately measure the electricity parameters such as voltage, current, power, frequency and others, and be connected to other devices for system networking.

The wide range of models cover most power monitoring and metering scenarios from single-phase to three-phase power supply, and from single circuit to dual circuits.

2.2 Highlights

- Easy installation and parameter setting
Features a small size and convenient DIN rail mounting that occupies little space, and supports setting parameters simply through the buttons.
- Accurate measurement and clear display
Precisely measures the voltage, current, positive and negative power, and other parameters, and displays the data on the wide LCD in real time.
- High security and compatibility
Conforms to national and international regulations on electrical equipment, and is compatible with multiple electrical devices that cover a wide range of application scenarios.

2.3 Appearance

The three meter models are consistent in appearance design, with the LCD and setting buttons on the front panel, the cable connection terminals on the top and bottom sides, the mounting sketch map on the left panel, and the wiring diagrams, certification labels and key parameters on the right panel.

M1-40

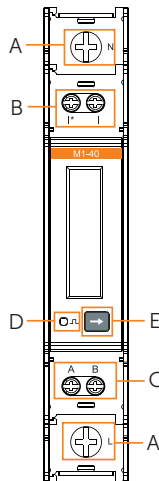

Figure 2-1 Appearance of M1-40

Table 2-1 Appearance description of M1-40

No.	Type	Marking	Definition
A		L	UL terminal, connected to the L wire of the grid
		N	UN terminal, connected to the N wire of the grid
B	Terminal	I*	Current input terminal, connected to the I* wire of CT
		I	Current output terminal, connected to the I wire of CT
C		A	RS485 terminal A
		B	RS485 terminal B
D	Indicator		Pulse indicator, flashes when the meter is working normally
E	Function button	→	Used to switch the display item

M3-40

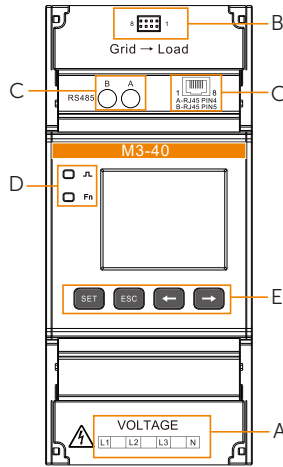



Figure 2-2 Appearance of M3-40

Table 2-2 Appearance description of M3-40

No.	Type	Marking	Definition
A		L1, L2 and L3	UL terminal, connected to the L wires of the grid
		N	UN terminal, connected to the N wire of the grid
B	Terminal	8 1	Current input terminal, connected to the batch of CTs
		A	RS485 terminal A
C		B	RS485 terminal B
		A-RJ45 PIN4	RJ45 PIN4: RS485 terminal A
		B-RJ45 PIN5	RJ45 PIN5: RS485 terminal B
D	Indicator		Pulse indicator, flashes when the meter is working normally
		Fn	Function indicator, flashes when the meter phase sequence is being adjusted
E	Function button	SET	Used when viewing power data on LCD and configuring parameters
		ESC	
		←	
		→	

M3-40-Dual

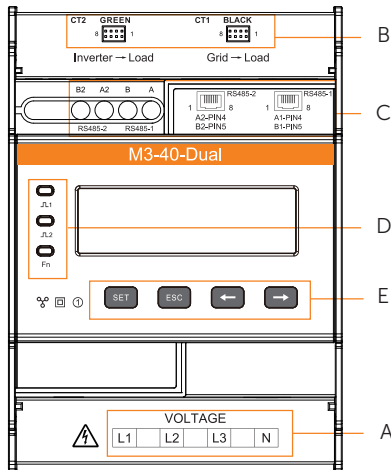

Figure 2-3 Appearance of M3-40-Dual

Table 2-3 Appearance description of M3-40-Dual

No.	Type	Marking	Definition
A		L1, L2 and L3	UL terminal, connected to the L wires of the grid
		N	UN terminal, connected to the N wire of the grid
B	Terminal	CT1 BLACK CT2 GREEN	Current input terminal, connected to the batch of CTs
		A/A2	RS485 terminal A
C		B/B2	RS485 terminal B
		A1-PIN4/A2-PIN4	RJ45 PIN4: RS485 terminal A
D	Indicator	B1-PIN5/B2-PIN5	RJ45 PIN5: RS485 terminal B
		\square 1 \square 2 Fn	Pulse indicator, flashes when the meter is working normally Function indicator, flashes when the meter phase sequence is being adjusted
E	Function button	SET	Used when viewing power data on LCD and configuring parameters
		ESC	
		←	
		→	

3 Typical Networking Diagrams

SolaX meters can be connected to inverters and other devices to form multiple types of power systems, and monitor and control the power consumption and storage of these systems. These meters can communicate with inverters through RS485 cables, and also be connected to Wi-BR for wireless data transmission.

When connected to Wi-BR, the data transmission distance can be expanded to up 200 meters horizontally and 20 meters vertically according to results of tests conducted in SolaX laboratories.

NOTICE!

- The CT must only be clipped onto the L wires.
- The cable length between CT and inverter should not exceed 100 meters.
- To protect the CT from falling off, we recommend wrapping the CT clip around in circles with insulating tape.
- When the system is powered on, ensure that the RS485 cables are kept separate from the power cables to protect the inverter from potential damages.

NOTICE!

- The following diagrams use European TN-S for example, and are for reference only.

M1-40

M1-40 can only be connected to single-phase inverters for power monitoring.

NOTICE!

Make sure the arrow on the CT is pointing at the inverter/load side from the grid side.

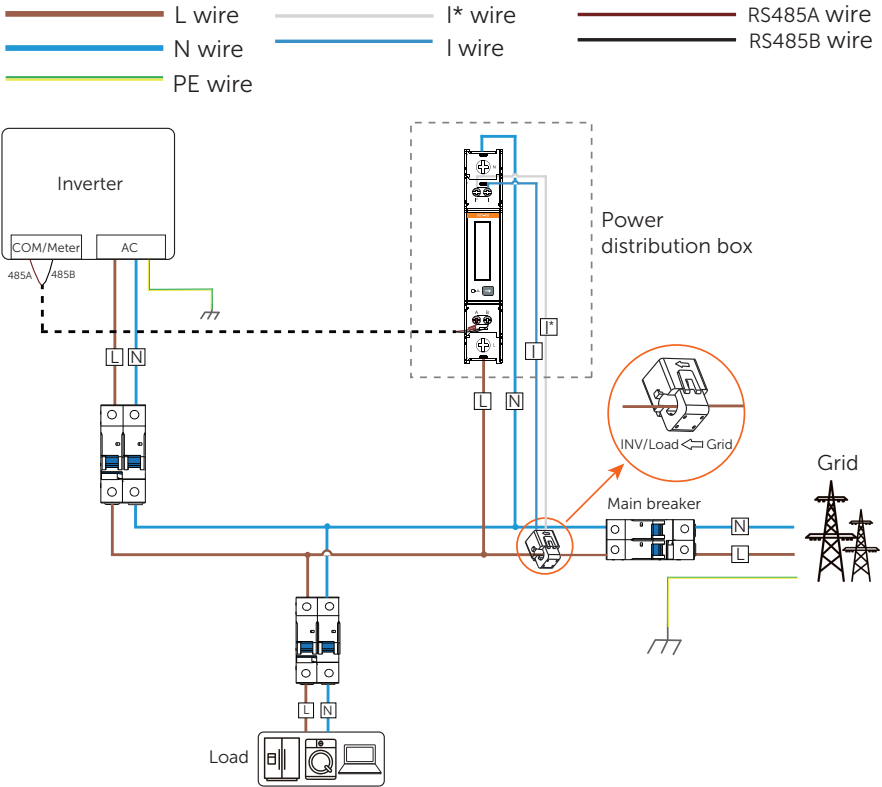

Figure 3-1 Networking through RS485 cable

Typical Networking Diagrams

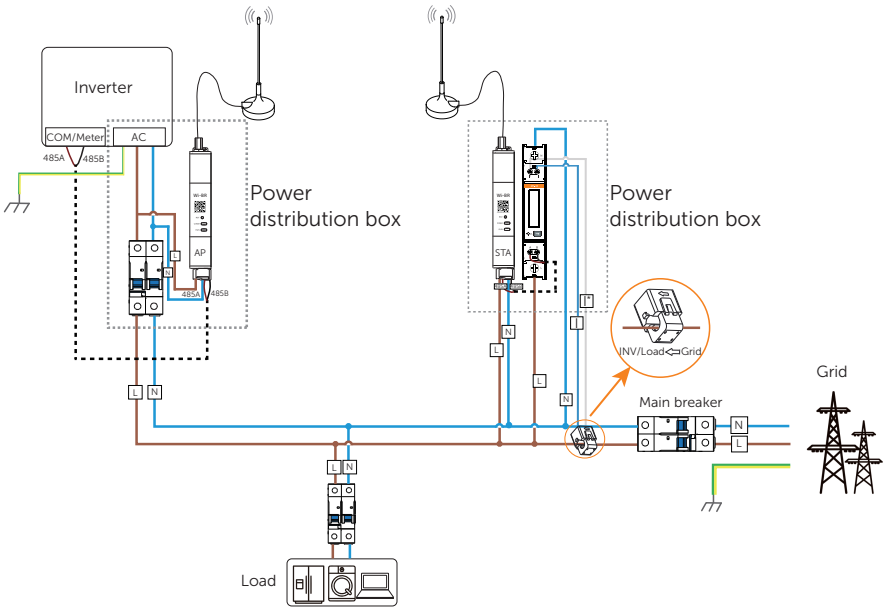











Figure 3-2 Wireless data transmission through Wi-BR

M3-40

M3-40 can be connected to both single-phase and three-phase inverters. When connected to single-phase inverter, make sure to connect the voltage output terminals of the inverter to terminal L1 and N of the meter.

NOTICE!

Make sure the arrow on the CT is pointing at the inverter/load side from the grid side.

- | | | | | | |
|---|---------|---|---------|---|-------------|
|  | L1 wire |  | I* wire |  | RS485A wire |
|  | L2 wire |  | I wire |  | RS485B wire |
|  | L3 wire |  | PE wire | | |
|  | N wire | | | | |

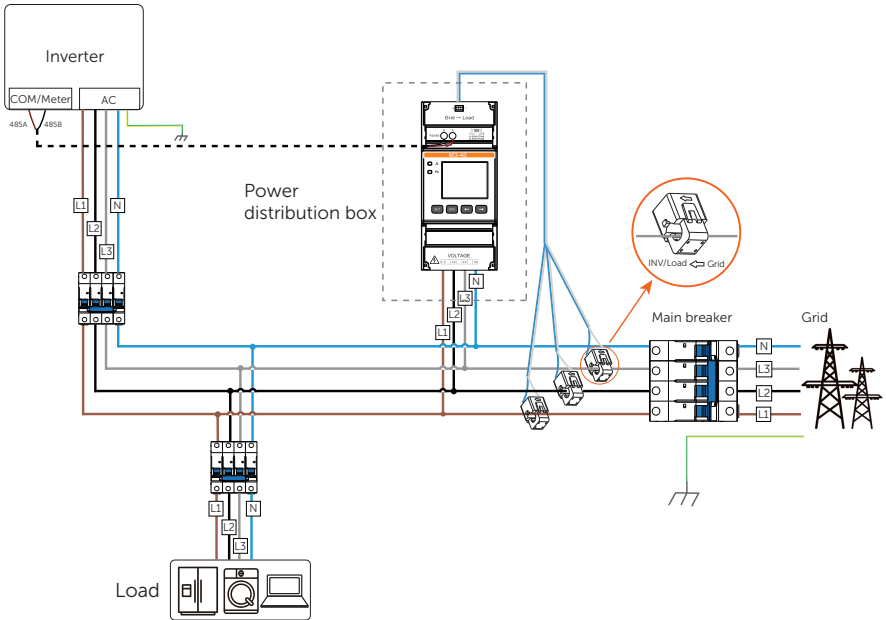

Figure 3-3 Networking through RS485 cable

Typical Networking Diagrams

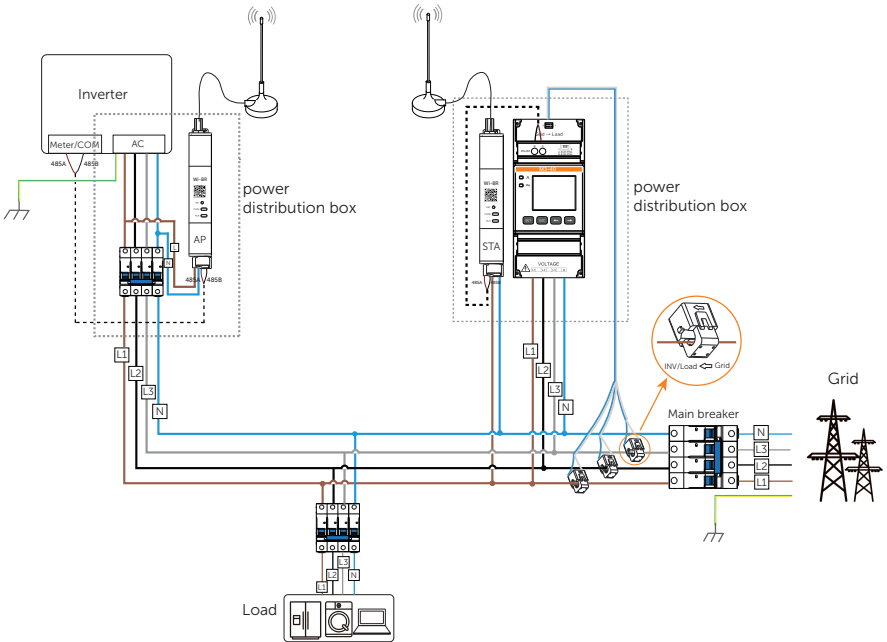

Figure 3-4 Wireless data transmission through Wi-BR

M3-40-Dual

M3-40-Dual offers two channels that can be used to monitor two power circuits at the same time. This is helpful when you have two power generation equipment at home and want to monitor them both without need for installing another metering device.

NOTICE!

CTs clipped onto the bus voltage cables must be pointing at the inverter/load side from the grid side, and CTs clipped onto the branch voltage cables must be pointing at the grid/load side from the third-party inverter.

- L1 wire
- L2 wire
- L3 wire
- N wire
- I* wire
- I wire
- PE wire
- RS485A wire
- RS485B wire

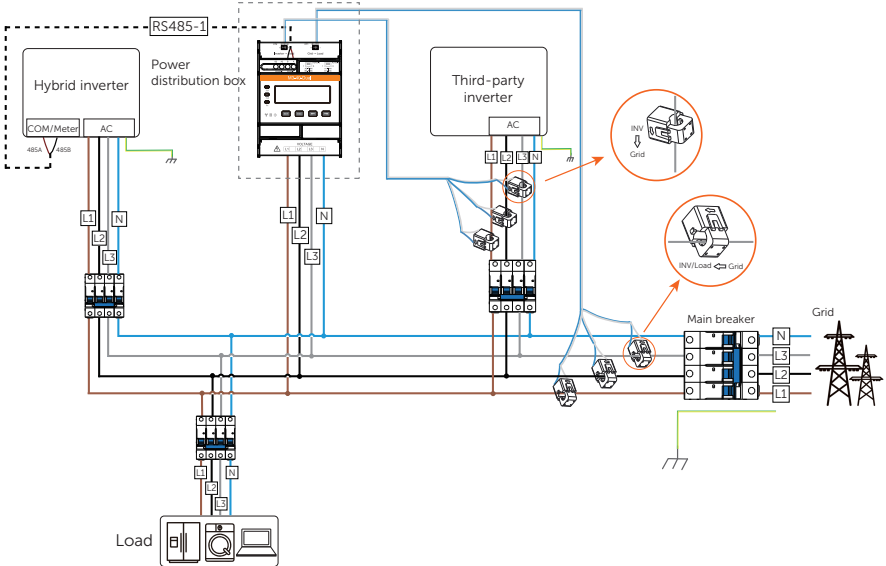

Figure 3-5 Networking through RS485 cable

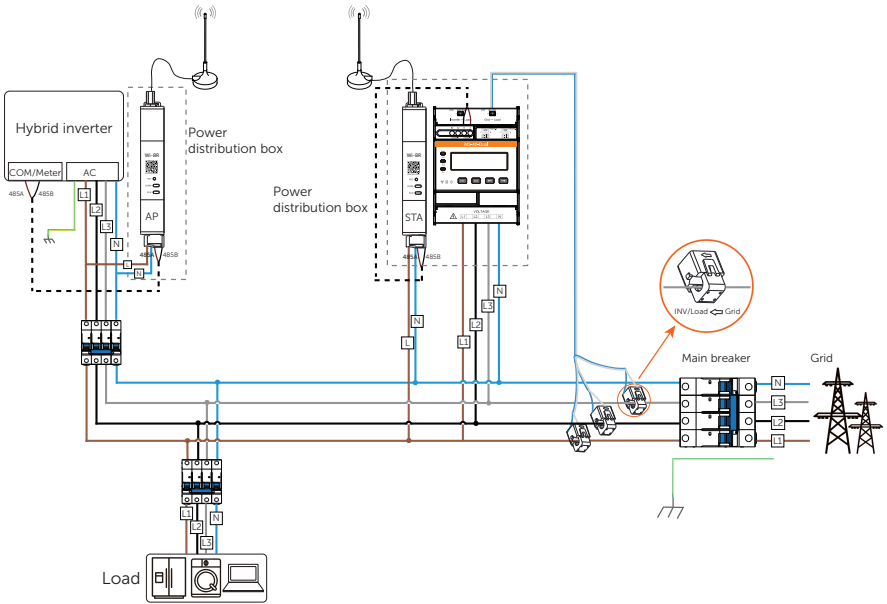

Figure 3-6 Wireless data transmission through Wi-BR

4 Unpacking and Inspection

4.1 Unpacking

These meters are well protected with plastic foams and packages upon delivery. However, damages may still occur during transportation. Upon acceptance, please verify the meter model, and carefully check the meter appearance for any sign of damages, such as punctures or cracks. If any damage is found, contact your supplier immediately.

4.2 Scope of Delivery

Accessories of each meter model are specified below. After unpacking, check the items against the packing list. If there is any part damaged or missing, contact your supplier.

M1-40

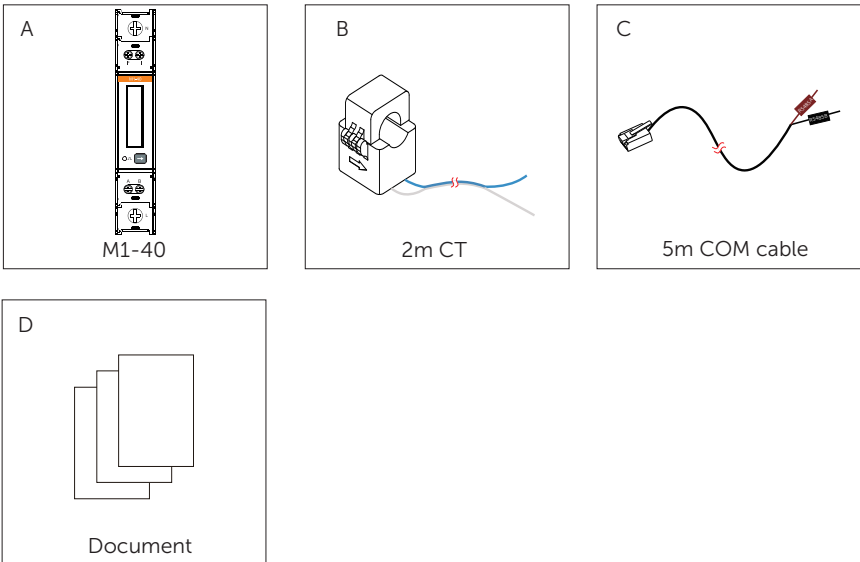

Figure 4-1 Packing list of M1-40

Table 4-1 Packing list of M1-40

No.	Item	Quantity	Remarks
A	M1-40	1	/
B	CT with 2m cable	1	/
C	5m communication cable with an RJ45 connector	1	For connecting inverters and Wi-BR
D	Document	/	/

M3-40

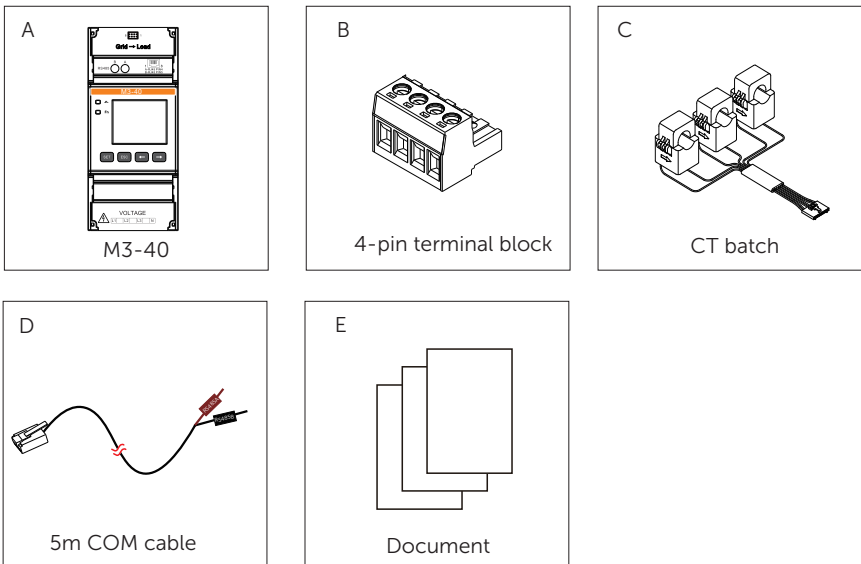

Figure 4-2 Packing list of M3-40

Table 4-2 Packing list of M3-40

No.	Item	Quantity	Remarks
A	M3-40	1	/
B	4-pin terminal block	1	For connecting the power cables
C	CT batch	1	/

No.	Item	Quantity	Remarks
D	5m communication cable with an RJ45 connector	1	For connecting inverters and Wi-BR
E	Document	/	/

M3-40-Dual

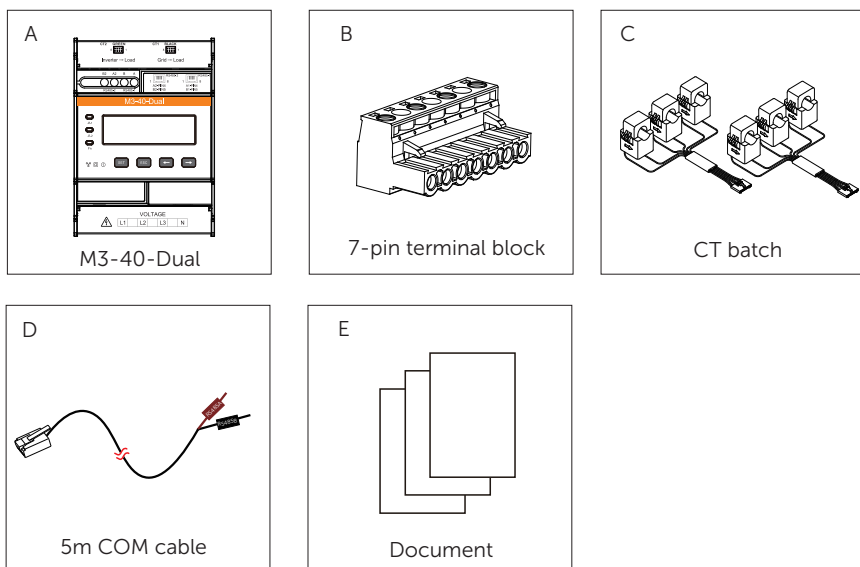

Figure 4-3 Packing list of M3-40-Dual

Table 4-3 Packing list of M3-40-Dual

No.	Item	Quantity	Remarks
A	M3-40-Dual	1	/
B	7-pin terminal block	1	For connecting the power cables
C	CT batch	2	/

Unpacking and Inspection

No.	Item	Quantity	Remarks
D	5m communication cable with an RJ45 connector	1	For connecting inverters and Wi-BR
E	Document	/	/

5 Cable Connection

5.1 Cable Requirements

For each meter model, we offer CT or CT batches with 2-meter cable, and a 5-meter communication cable with an RJ45 connector. In addition, you will need to prepare extra cables based on the table below.

Table 5-1 Cable requirements

Usage	Terminal marking	Cable type (Recommended)	Sectional area (mm ²)	Outer diameter (mm)	Prepared by
Voltage cable	<ul style="list-style-type: none"> • L • L1, L2, L3 <hr/> N	Multi-core outdoor copper wire	1.5~2.5	3~5	User
CT cable	<ul style="list-style-type: none"> • I*, I • Grid→Load • CT1 BLACK • CT2 GREEN 	/	/	/	Supplier
COM cable	RS485A <hr/> RS485B	Two-core outdoor shielded twisted pair cable	0.25~1.5	4~11	Supplier
	RJ45	CAT6	/	/	

5.2 Connection Procedure

Connect the power cable, CT cable and communication cable for the meters.

WARNING!

- Only the qualified personnel can perform the electric connection following local standards and requirements.
- Before connecting cables for the meter, make sure that the meter is in good condition and that the power supply has been cut off.

NOTICE!

This manual only introduces the wiring procedure of the meter side. For the connection of the other end of these cables, see the user manual of the corresponding device.

5.2.1 Power Cable Connection

M1-40

Step 1: Strip the insulation layer off the voltage cables to an appropriate length.

Step 2: Insert the conductors into the L and N terminals according to the meter markings, and then use a torch screwdriver to secure the connection.

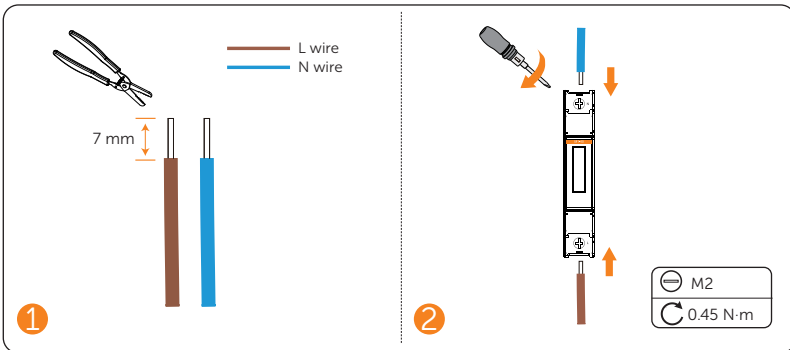

Figure 5-1 Connecting power cables for M1-40

M3-40 & M3-40-Dual

NOTICE!

- M3-40 and M3-40-Dual meter models share the power cable connection procedure, but make sure the cables are connected conforming to the cable sequence markings.
- When M3-40 and M3-40-Dual is connected to single-phase inverters, ensure that the voltage output cables are connected to L1 and N terminals.

- Step 1:** Strip the insulation layer off the voltage cables to an appropriate length.
- Step 2:** Insert the conductors into the terminal block according to the meter marking sequence, and then use a torch screwdriver to secure the connection.
- Step 3:** Insert the connected terminal block into the meter.

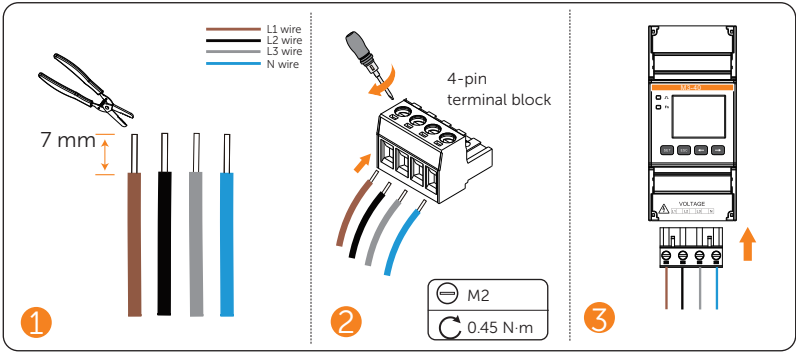

Figure 5-2 Connecting power cable for M3-40

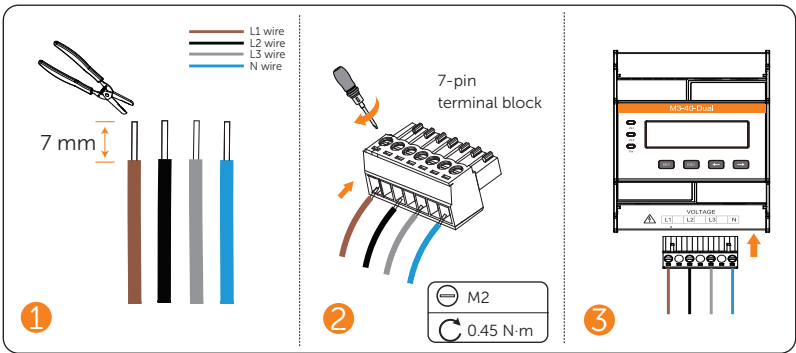

Figure 5-3 Connecting power cable for M3-40-Dual

5.2.2 CT Cable Connection

Connect the CT to the meter, and clip the CT onto the L wires.

NOTICE!

Pay special attention to the direction of arrow on the CT.

M1-40

Step 1: Insert the I* and I wire of the CT into the corresponding terminals based on the meter markings, and then use a torch screwdriver to secure the connection.

Step 2: Clip the CT onto the L wire.

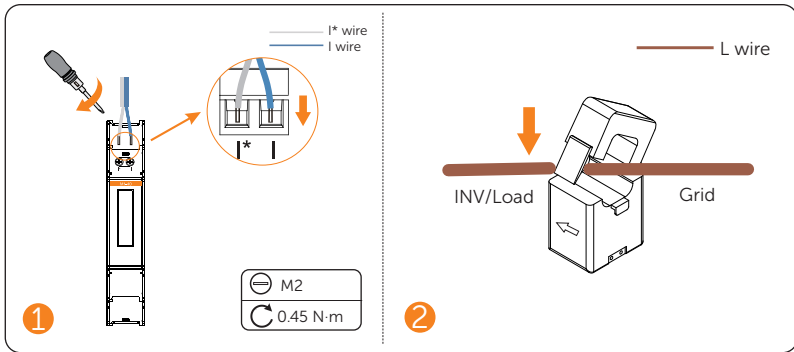

Figure 5-4 Connecting CT cables for M1-40

M3-40 & M3-40-Dual

We offer plug-and-play CT batch for three-phase meters. You can directly plug the CT terminal into the CT port, and then clip the CTs respectively onto the L wires.

NOTICE!

The CT connection procedure of all three-phase meter models are the same. The following diagram uses M3-40 for example.

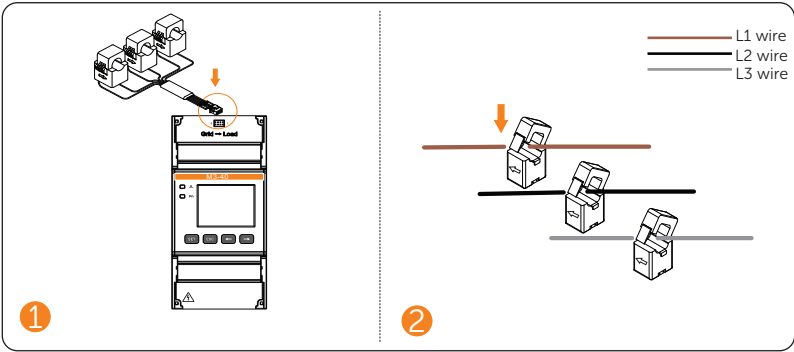

Figure 5-5 Connecting CT cable for M3-40

5.2.3 Communication Cable Connection

We offer a 5m communication cable with an RJ45 connector for each meter model. You can simply plug the conconnector into the meter RJ45 terminal, or connect the meter through the RS485 terminal if needed.

M1-40

Insert RS485 A and B wires into the meter terminals according to the meter markings, and then use a torch screwdriver to secure the connection.

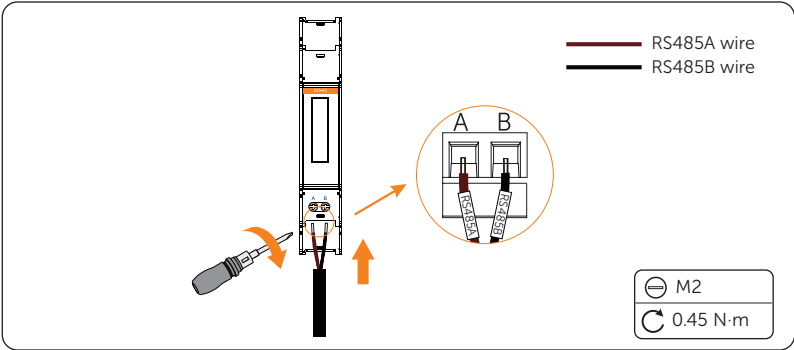

Figure 5-6 Connecting communication cable for M1-40

M3-40 & M3-40-Dual

The three-phase meter models offer two types of communication terminals. You can connect the communication cable for these meters either through the RS485 terminal or the RJ45 terminal based on on-site conditions.

NOTICE!

The communication cable connection procedure of all three-phase meter models are the same. The following diagram uses M3-40 for example.

- Connection through RJ45 terminal

The communication cable delivered with the meter already has PIN4 and PIN5 connected. Therefore, you can directly insert the RJ45 connector into the RJ45 terminal of the meter.

Table 5-2 Corresponding Pin No and color

PIN No.	Color	PIN No.	Color
4	Blue	5	Blue-White

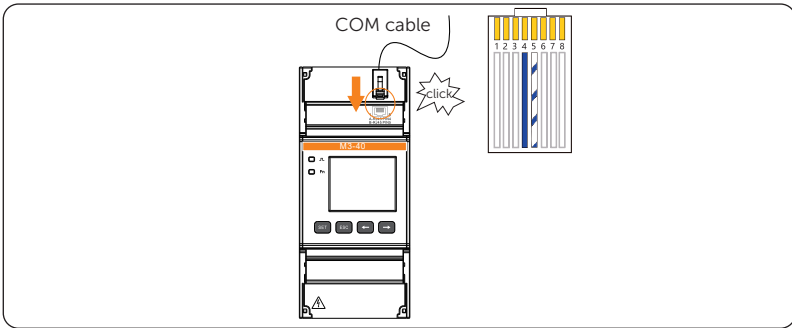

Figure 5-7 Communication cable connection through RJ45 terminal

- Connection through RS485 terminal

Insert the RS485 A and RS485 B wires into the corresponding terminals, and then use a torch screwdriver to secure the connection.

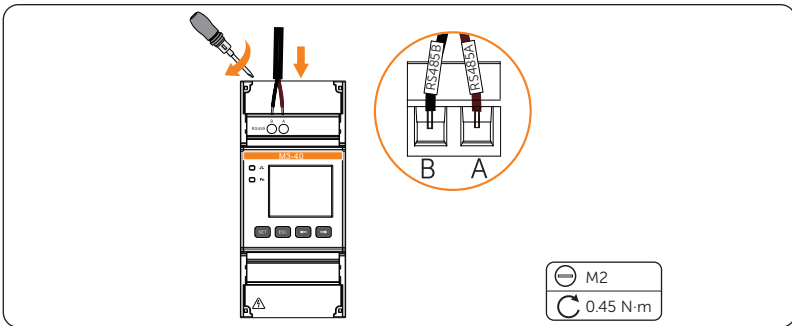

Figure 5-8 Communication cable connection through RS485 terminal

6 Mechanical Installation

All these meters are designed to be installed onto the 35 mm DIN rail inside the power distribution box.

WARNING!

- Only the qualified personnel can perform the mechanical installation following local standards and requirements.
- Before mounting the meter, make sure that the meter is in good condition and that the power has been cut off.

NOTICE!

We recommend connecting all cables for the meter before mounting it onto the rail.

Mount the meter onto the 35mm DIN rail, and then clip it to the rail with strength.

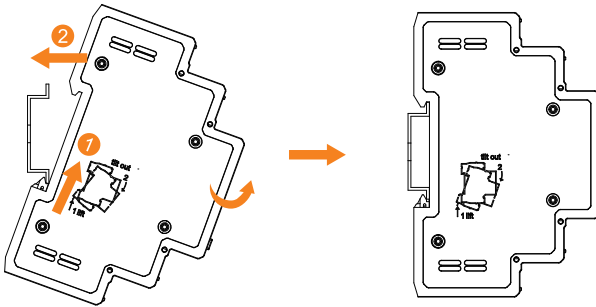

Figure 6-1 Mounting the meter

7 LCD Display

The meter LCD can display multiple items, such as positive active energy, reverse active energy, current, power, and more. The default display item is positive active energy.

You can press the ← and → button on the front panel to switch among the display items.

NOTICE!

- The following display item images are for reference, and might differ from the screen of the actual product.
- The display sequence of the items in tables below is for illustration only, and might differ from the display sequence of the actual product.

Table 7-1 Description of buttons for viewing data

Button	Description
←	Go to the previous item
→	Go to the next item

M1-40



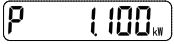
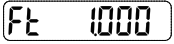

Figure 7-1 M1-40 display

NOTICE!

The minus sign (-) on the display means reverse active energy.

Table 7-2 Parameters displayed on M1-40

No.	Item	Description	No.	Item	Description
1		Positive active energy=2.200 kWh	2		Reverse active energy=2.200 kWh
3		Voltage=220.0 V	4		Current=5.000 A

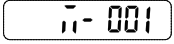
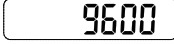
No.	Item	Description	No.	Item	Description
5		Active power=1.100 kW	6		Power factor PFT=1.000
7		Frequency=50.000 Hz	8		Communication protocol: Modbus; Communication address: 1
9		Communication baud rate: 9600			

M3-40

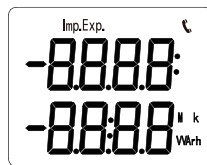



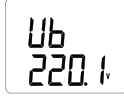









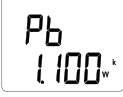





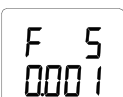
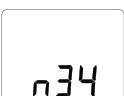



Figure 7-2 M3-40 display

Table 7-3 Parameters displayed on M3-40

No.	Item	Description	No.	Item	Description
1		Positive active energy=10000.00 kWh	2		Reverse active energy=2345.67 kWh
3		Phase A voltage=220.0 V	4		Phase B voltage=220.1 V
5		Phase C voltage=220.2 V	6		Line voltage Uab=220.0 V
7		Line voltage Ubc=220.0 V	8		Line voltage Uca=220.0 V

No.	Item	Description	No.	Item	Description
9		Phase A current=5.000 A	10		Phase B current=5.001 A
11		Phase C current=5.002 A	12		Combined phase active power=3.291 kW
13		Phase A active power=1.100 kW	14		Phase B active power=1.100 kW
15		Phase C active power=1.100 kW	16		Combined phase power factor PFt=1.000
17		Phase A power factor PFa=1.000	18		Phase B power factor PFb=1.000
19		Phase C power factor PFc=1.000	20		Frequency=50.001 Hz
21		Current wiring mode: 3P4W	22		Communication protocol: Modbus; Communication address: 1
23		Communication baud rate: 9600			

M3-40-Dual











Figure 7-3 M3-40-Dual display

Table 7-5 Parameters displayed on M3-40-Dual

No.	Item	Description	No.	Item	Description
1		Total energy of the circuits =10000.00 kWh	2		Positive active energy of Circuit 1=10000.00 kWh
3		Positive active energy of Circuit 2=10000.00 kWh	4		Reverse active energy of Circuit 1=2345.67 kWh
5		Reverse active energy of Circuit 2=2345.67 kWh	6		Phase A voltage=220.0 V
7		Phase B voltage=220.1 V	8		Phase C voltage=220.2 V
9		Line voltage Uab=220.0 V	10		Line voltage Ubc=220.1 V
11		Line voltage Uca=220.2 V	12		Phase A current of Circuit 1=5.000 A
13		Phase B current of Circuit 1=5.001 A	14		Phase C current of Circuit 1=5.002 A

No.	Item	Description	No.	Item	Description
15		Phase A current of Circuit 2=5.000 A	16		Phase B current of Circuit 2=5.001 A
17		Phase C current of Circuit 2=5.002 A	18		Combined phase active power of Circuit 1=3.291 kW
19		Phase A active power of Circuit 1=1.100 kW	20		Phase B active power of Circuit 1=1.100 kW
21		Phase C active power of Circuit 1=1.100 kW	22		Combined phase active power of Circuit 2=3.291 kW
23		Phase A active power of Circuit 2=1.100 kW	24		Phase B active power of Circuit 2=1.100 kW
25		Phase C active power of Circuit 2=1.100 kW	26		Combined phase power factor of Circuit 1=0.500
27		Phase A power factor of Circuit 1=1.000	28		Phase B power factor of Circuit 1=1.000
29		Phase C power factor of Circuit 1=1.000	30		Combined phase power factor of Circuit 2=0.500
31		Phase A power factor of Circuit 2=1.000	32		Phase B power factor of Circuit 2=1.000

No.	Item	Description	No.	Item	Description
33		Phase C power factor of Circuit 2=1.000	34		Frequency of Circuit 1= 50.001 Hz
35		Frequency of Circuit 2= 50.001 Hz	36		Current wiring mode: 3P4W
37		Circuit 1: Communication protocol: Modbus; Communication address: 1	38		Circuit 2: Communication protocol: Modbus; Communication address: 2
39		Communication baud rate of Circuit 1: 9600	40		Communication baud rate of Circuit 2: 9600

8 Parameter Setting

Set parameters for the meter to suit the operations of other devices through the buttons on the front panel.





NOTICE!

- Currently, M1-40 does not support setting parameters. Therefore, this chapter only applies to M3-40 and M3-40-Dual.
- The following images of the displayed items are for reference only, and might differ from the display of the actual product.

8.1 Parameter Description

Multiple parameters can be set, such as current ratio, voltage ratio, communication address and more. For dual-circuit meters, you can configure communication address respectively for the two circuits.

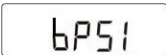
Table 8-1 Parameter description of M3-40&M3-40-Dual

No.	Parameter	Value range	Description
1		1~9999	Current ratio, used for setting the input loop current ratio.
2		0.1~999.9	Voltage ratio, used for setting the input loop voltage ratio.
3		<ul style="list-style-type: none">• 1• 2	Communication address
4		9600	Baud rate. It is 9600 by default and cannot be modified on the meter.
5		<ul style="list-style-type: none">• n.34• n.33	Wiring mode: <ul style="list-style-type: none">• 0: n.34 represents 3 phase 4 wire• 1: n.33 represents 3 phase 3 wire
6		0: No; 1: E;	Clear the historical data: <ul style="list-style-type: none">• 0: Do not clear the data. It is enabled by default.• 1: Clear the historical data

No.	Parameter	Value range	Description
7		0: No; 1: E;	Restore the meter to factory settings <ul style="list-style-type: none"> • 0: Do not clear the meter settings • 1: Restore the meter to factory settings

8.2 Setting Procedure

For ease of use, most parameters are preset in accordance with the requirements for operation with SolaX inverters upon delivery. You can also modify the configurations through the function buttons if needed.

Table 8-2 Button description

Button	Description
SET	<ul style="list-style-type: none"> • Enter the parameter setting interface • Confirm the selection • Shift the cursor (when inputting digits)
ESC	Exit from the current interface
←	<ul style="list-style-type: none"> • Go to the previous item • Decrease the value
→	<ul style="list-style-type: none"> • Go to the next item • Increase the value

NOTICE!

Password verification is required for parameter setting. The default password is 717.

Setting the transformer current and voltage ratio

The current ratio of the included CT model is 40, and it is preconfigured upon delivery. If there is any inconsistency, or if you have changed the CT model, follow the steps to set the current and voltage ratio.

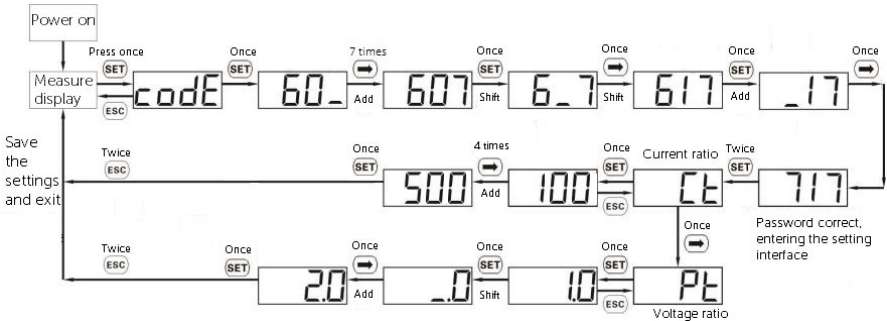

Setting the communication address

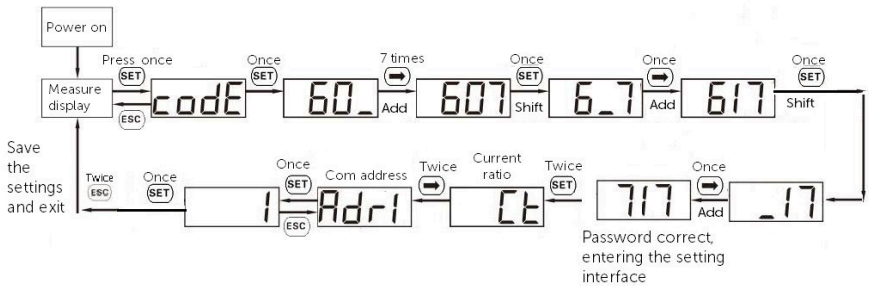

Setting baud rate

The baud rate of the meters for communication with SolaX inverters is 9600 by default, which cannot be modified on the meter. If you have to change the baud rate for the meter, configure it on the inverter.

Setting the power grid type

Set the power grid type to 3-phase 4-wire (3P4W) or 3-phase 3-wire (3P3W).

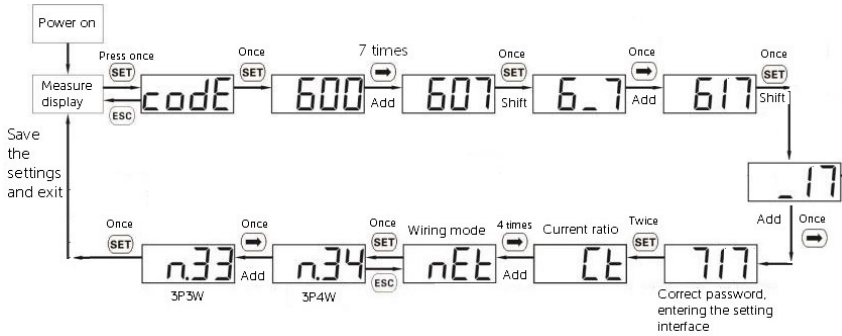

Clearing historical data

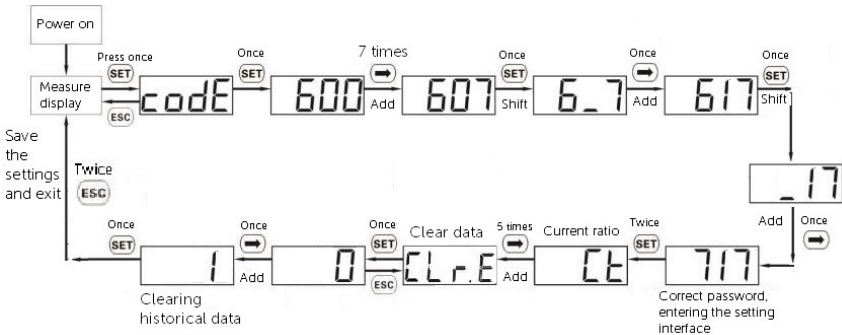

Restoring to factory settings

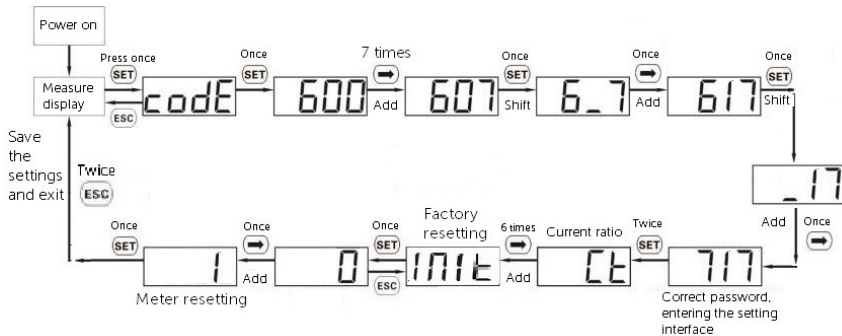

9 Troubleshooting

Followings are common problems with the meter when used with inverters. When a problem occurs, check the questions below for possible reasons and solutions. For further assistance, contact SolaX after-sales service.

01 What if the inverter LCD or SolaXCloud reports a **MeterFault** alarm when the meter is connected to and enabled on the inverter?

The inverter reports a **MeterFault** alarm when it fails to communicate with the meter. Please follow the steps to troubleshoot:

- Step 1:** Check the wiring of the meter and inverter based on the wiring diagrams. Make sure the RS485 terminals of the meter are correctly connected to the corresponding terminals of the inverter. For pin definition of different inverter models, see "Compatible Inverters and Pin Definition" and the user manual of the inverter.
- Step 2:** Contact the distributor or SolaX technical support.

02 What if the meter readings, such as power, do not match the actual situation?

Abnormal meter reading might result from incorrect wiring, improper CT connection, inconsistent parameter settings and more of the meter.

Following are common problems with abnormal meter readings and methods to fix them. For other situations, contact the distributor or SolaX technical support.

- The power reading of a phase is opposite to the actual power flow. For example, the actual power flow is importing 2 kWh, but the reading is exporting 2 kWh.
In this case, check whether the CT direction and current input and output wires are correctly connected. CTs on the bus line must point away from the grid to the inverter or load.
- The reading is proportionally larger or smaller than the actual value. For example, the actual export power is 2 kWh, but the reading is 1 kWh.
In this case, check whether the current ratio set on the meter corresponds to the CT specification. If not, see "Setting the transformer current and voltage ratio" to reset it.





10 Technical Data

Model	M1-40	M3-40	M3-40-Dual
Power grid type	1P2W	3P3W/3P4W	3P3W/3P4W
Rated voltage	220V...240V	3*220/380V...3*240/415V	3*57.7/100V...3*240/415V
Operating voltage	100 V~288 V	100 V~280 V	50 V~480 V
Current	*A/40 mA		
Recommended CT specification	100 A/40 mA; 200 A/40 mA	100 A/40 mA; 200 A/40 mA; 400 A/40 mA; 600 A/40 mA; 1000 A/40 mA;	
Power consumption	<1.2 W		
Measurement accuracyclass	Voltage and current: Class 0.5		
	Active power: Class 1		
	Reactive power: Class 2		
Resolution requirement	Active power: 0.1 W		
	Frequency: 0.001 Hz		
Frequency	45 Hz~65 Hz		
Frequency tolerance	0.01 Hz		
Operating temperature	-40°C to +70°C		
Operating humidity	≤95% , non-condensing		
Operating altitude	<4000 m		
Degree of protection	IP20		
Dimensions (mm) (W × H × D)	18 × 100 × 65.5	45 × 100 × 65.5	72 × 100 × 65.5

11 Appendix

M1-40

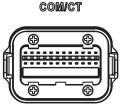

can only be connected to single-phase inverters. It is compatible with the following single-phase inverters. While connecting the cables, pay special attention to the connector type and the pin number of the inverter.

Inverter series	Terminal type	Connector type	Pin No.	Pin definition	Remarks
X1-HYB LV		RJ45	4	485A	Select either COM1, COM2 or COM3
			5	485B	
X1-AC		RJ45	7	485A	—
			8	485B	
<ul style="list-style-type: none"> • X1-HYB G4 • X1-FIT G4 • X1-IES • X1-VAST 		RJ45	4	485A	—
			5	485B	
<ul style="list-style-type: none"> • X1-MINI G4 • X1-BOOST G4 		RJ45	4	485A	—
			5	485B	
X1-SMART G2		Quick-connect terminal	4 / 11	485A	—
			5 / 12	485B	

*Note: Two pairs of terminals are available for meter connection on X1-Smart G2, and the pins in the same box are a pair.

M3-40&M3-40-Dual

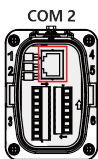
M3-40 and M3-40-Dual can be connected to both single-phase and three-phase inverters. Therefore, besides the above the single-phase inverters, it is also compatible with the following three-phase inverters.

Inverter series	Terminal Type	Connector type	Pin No.	Pin definition
<ul style="list-style-type: none"> X3-HYB G4 X3-FIT G4 X3-IES X3-HYB G4 PRO 	 Meter/CT	RJ45	4	485A
			5	485B
X3-ULTRA	 COM 2	RJ45	4	485A
			5	485B
X3-MIC G2	 RS485	RJ45	4	485A
			5	485B
X3-PRO G2	 RS485	O/I terminal	5	485A
			6	485B

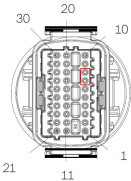
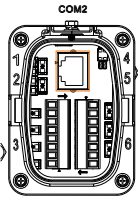
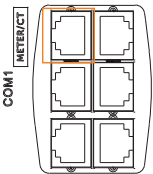
Inverter series	Terminal Type	Connector type	Pin No.	Pin definition
<ul style="list-style-type: none"> X3-MEGA G2 X3-FORTH 		Quick-connect terminal	7	485A
			8	485B
X3-AELIO		RJ45	4	485A
			5	485B
X3-HYB G4 PRO		RJ45	4	485A
			5	485B

Contact Information



UNITED KINGDOM

- 📍 Unit C-D Riversdale House, Riversdale Road, Atherstone, CV9 1FA
- ☎ +44 (0) 2476 586 998
- ✉ service.uk@solaxpower.com



TURKEY

- 📍 Fevzi Çakmak mah. aslım cd. no 88 A Karatay / Konya / Türkiye
- ✉ service.tr@solaxpower.com



USA

- 📍 3780 Kilroy Airport Way, Suite 200, Long Beach, CA, US 90806
- ☎ +1 (408) 690 9464
- ✉ info@solaxpower.com



POLAND

- 📍 WARSAW AL. JANA P. II 27. POST
- ☎ +48 662 430 292
- ✉ service.pl@solaxpower.com



ITALY

- ☎ +39 011 19800998
- ✉ support@solaxpower.it



PAKISTAN

- ✉ service.pk@solaxpower.com



AUSTRALIA

- 📍 21 Nicholas Dr, Dandenong South VIC 3175
- ☎ +61 1300 476 529
- ✉ service@solaxpower.com



GERMANY

- 📍 Am Tullnaupark 8, 90402 Nürnberg, Germany
- ☎ +49 (0) 6142 4091 664
- ✉ service.eu@solaxpower.com
- ✉ service.dach@solaxpower.com



NETHERLANDS

- 📍 Tweekeler-Es 15 7547 ST Enschede
- ☎ +31 (0) 8527 37932
- ✉ service.eu@solaxpower.com
- ✉ service.bnl@solaxpower.com



SPAIN

- ☎ +34 9373 79607
- ✉ tecnico@solaxpower.com



BRAZIL

- ☎ +55 (34) 9667 0319
- ✉ info@solaxpower.com



SOUTH AFRICA

- ✉ service.za@solaxpower.com



SolaX Power Network Technology (Zhejiang) Co., Ltd.

Add.: No. 278, Shizhu Road, Chengnan Sub-district, Tonglu County,
Hangzhou, Zhejiang, China
E-mail: info@solaxpower.com

Copyright © SolaX Power Network Technology (Zhejiang) Co., Ltd. All rights reserved.



320101117100